



Ultimate



Luxury

2012-2013 POSH PILE® INTERIOR INNOVATIONS CATALOG

Right Hand Drive Edition

Thank you for thinking of Posh Pile. The items in this catalog are designed by car enthusiasts for car enthusiasts.

Thanks to you, Posh Pile is widely distributed throughout Asia, New Zealand, and the Middle East, and in the coming months we will have a major North American market launch.

Posh Pile is a hot retail line!



At major retailers



In the best auto accessory shops



On end caps

Thanks to you, magazines have written great articles about Posh Pile.



Britcham Hong Kong



Automobile



HKTDC

And U.S. end users on eBay have given Posh Pile U.S. a perfect 5.0 score.

Detailed Seller Ratings (last 12 months)		
Criteria	Average rating	Number of ratings
Item as described	★★★★★	26
Communication	★★★★★	26
Shipping time	★★★★★	26
Shipping and handling charges	★★★★★	26

Thanks to you, Posh Pile is growing like crazy on the internet. We have almost 70 videos on our YouTube channel. Our videos are the most viewed car mat videos on this the 2nd biggest search engine on the planet. Over 51,000 car enthusiasts have viewed them.

We have:

- 18 of top 20 videos for search of "direct fit car mats"
- 3 of top 5 videos for search of "BMW car mats"
- 3 of top 4 videos for search of "Mini car mats"

Please check out our facebook page: www.facebook.com/PoshPile and 'Like' us.

But most of all: tell your friends about Posh Pile!

Thank you
The Posh Pile Team



INTRODUCTION

What is Posh Pile®?:

Posh Pile® Ultimate Luxury car mats were created by an avid car enthusiast. He went to hundreds of car shows globally for ten years while launching the leading brand of car care products from the U.S.A. He found his factory mats wore out in one to two years. Because there were no higher quality mats available for car enthusiasts, he created the Posh Pile® brand. Our brand has expanded to offer the very highest quality car mats, interior, and car detailing accessories drawing on our founder's knowledge of car detailing and his quest for the very best!



According to Webster's New World Dictionary, Posh Pile® is defined as:

Posh: adjective: luxurious and fashionable

Pile: a soft, velvety raised surface of yarn loops, often sheared, as on a rug

AT POSH PILE®, WE OFFER:

1. Carpet car mats: Pages 5-9

5TH Avenue is the flagship product of Posh Pile®.

Posh Pile® 5TH Avenue Special Features



Nylon Woven Heel Pad



Laser Cutting Sewn Edge



Full Rubber Backing

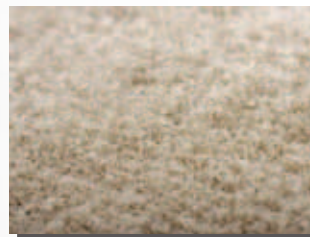

Thickest Posh Pile

2. Synthetic rubber car mats: Pages 10-11

Weather Fortress™ Special Features



Edges can be trimmed for a custom fit



Raised lip to contain moisture

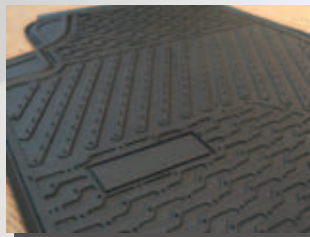

Anti-skid spiked backing



Genuine Weather Fortress emblem



3. Trunk organization: Page 20

Trunk/Boot Storage Bag Special Features



Soft carpet bags that match your boot perfectly

Weather Fortress™ Trunk/Boot Mat Special Features



Unique diamond plate design ensures your cargo stays put

4. Interior Care: Page 20

12-Volt Car Vacuum Special Features



Long lasting high power not found in rechargeables

5. Exterior Care: Page 21-23

12-Volt & 220-Volt Random Orbital Polisher Special Features



A complete swirl removal system, just add chemicals

Foam Polishing Pad Special Features



Professional grade hook and loop fastening system

Microfiber Car Duster Special Features



Attracts dirt and dust to clean safely

Microfiber Wash Glove Special Features



Great for your hand, safe for your paint

Wash Glove Handle Special Features



Turns the Wash Glove into a clean anywhere tool

Car Shampoo Sponge Special Features



A quality sponge that is an amazing value

Wheel Spoke Brush Special Features



Unique Posh Pile® design cleans all the nooks and crannies

Advanced Wheel Face Brush Special Features



Unique Posh Pile® design pampers your wheels



FREQUENTLY ASKED QUESTIONS

How can I know if Posh Pile® mats will fit my car?

Posh Pile® has an application guide on pages 13 to 19. For the latest up-to-date version, log on to our website at: www.poshpile.com.

- Our universal carpet mats fit **over 90%** of vehicles tested
- Our Weather Fortress™ rubber mats fit **over 99%** of vehicles tested

Please understand that universal mats are designed to fit the majority of passenger cars, MPVs, light trucks, and SUVs. As such, they are a compromise and in some cases they can be a bit narrower than the original factory mat.

Do I need universal or direct fit mats for my car?

The truthful answer is: *it depends.*

If you have a car with a floor mounted accelerator pedal like a Mini or most BMWs, then you need a direct fit mat.

- Over 80% of today's cars have the accelerator, brake pedal, and clutch hanging from the dashboard, so universal mats with the right "cut" can fit most cars nicely.

If you have a typical two or four door passenger car, most likely, a universal mat will fit your car.

- Universal mats can save you anywhere from 30-80% compared to the cost of direct fit mats from a car dealer!

Two Examples:

Universal Floor Mat Application



Posh Pile® Universal Mats in a 2011
Mercedes-Benz R350L

Direct Fit Floor Mat Application



Posh Pile® Direct Fit Mats in a 2011
Volkswagen Golf Mk6

Why use Posh Pile® mats?

Our mats will upgrade your interior by offering a thick, new luxury look. They also protect your interior from grease, oil, road tar, and even wear and tear.



There's three types of Posh Pile® carpet mats, what's the difference?



5TH Avenue™
Our very best, most luxurious car mat



Pacific Coast Highway™
Our full-featured luxury mat at a value price



Stay Tuned™
Innovative hook and loop mat pioneered in Japan for high performance & better fuel economy

Why do rubber car mats smell?

Real rubber smells, but most rubber car mats aren't actually made of rubber. PVC is the most common material, which sometimes can have a really strong odor. Posh Pile® mats do not have any bad rubber smell because they're made of advanced TPR, thermoplastic rubber.

What makes the best rubber mat?

It's all about the material. PVC is the lowest quality, while synthetic rubber materials like TPR (thermoplastic rubber) are the highest quality available for rubber mats.

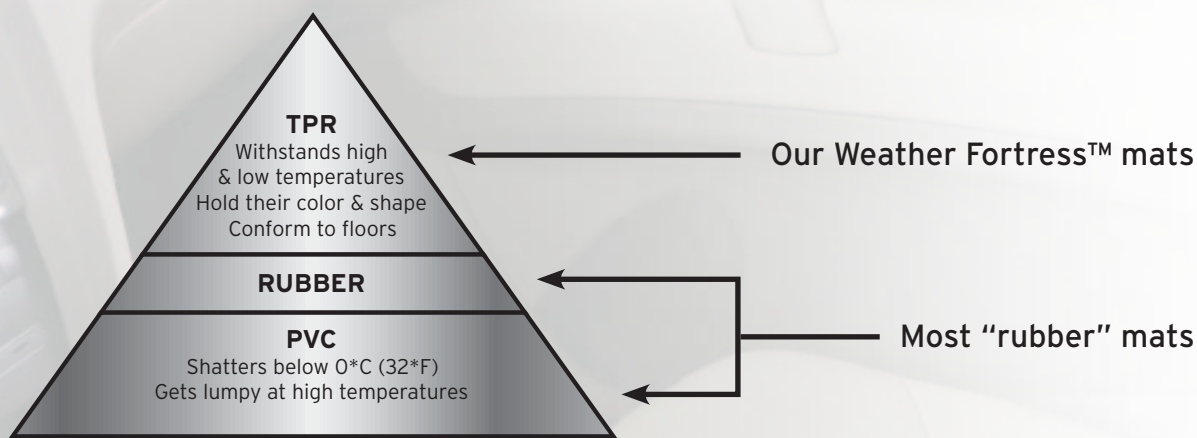

How do I trim my Weather Fortress™ mats?

Simply use a pair of scissors to trim just outside of the secondary raised lip for a great looking custom fit mat!



For more FAQ's, check out our website: www.poshpile.com



5TH AVENUE™ ULTIMATE LUXURY MATS



The thickest luxurious posh carpet pile



Waterproof rubber non-skid backing

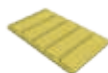

Premium long-wearing nylon heel pad



Exclusive OE style woven edge



UV and stain resistant



TAN/BEIGE
5 PIECE SET
PART # 80509



GREY
5 PIECE SET
PART # 80507



BLACK
5 PIECE SET
PART # 80508

- Rubber waterproof non-skid backing for long, dependable life
- 5 piece carpet set
- Thickest quality mats available
- Premium long wearing nylon heel pad
- High quality woven edges
- UV and stain resistant

Our flagship product!



Posh Pile®
5TH Avenue™ Mats
in a 2010 Toyota Corolla



Posh Pile® 5TH Avenue™
Mats in a 2012 Ford Focus

5TH Avenue™ Gallery



5TH Avenue™ in a
2012 Audi A7



5TH Avenue™ in a
2007 Volvo XC90

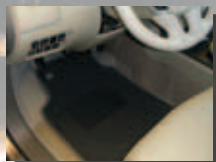

5TH Avenue™
in a 2012 Nissan
Murano



5TH Avenue™ in
a 2007 Porsche
Cayenne



5TH Avenue in a
2012 Mitsubishi
Outlander



5TH Avenue™ in a
2009 Alfa Romeo
Brera

"Wow these mats are the BOMB! You cannot buy a more plush mat"
Posh Pile® US Customer

OUR LUXURY MAT!



WWW.POSHPILE.COM

5TH AVENUE™ DIRECT FIT MATS



The thickest luxurious posh carpet pile



Waterproof rubber non-skid backing

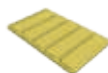

Premium long-wearing nylon heel pad



Exclusive OE style woven edge



UV and stain resistant

- Custom tailored fit
- Woven nylon heel pad
- Plusher than OEM mats
- High thread count sewn edges
- Thickest direct fit mats available
- Feature OEM fasteners



1996-2004 Porsche Boxster (986)
(PART # 90008 - BLACK)



1998-2005 Porsche (996)
(PART # 160248 - BLACK)



2004-2010 BMW 5-Series (E60)
(PART # 30608 - BLACK)



1998-2011 BMW 3-Series (E46/E90)
(PART # 30908 - BLACK)



2007-Present Mini (R56)
(PART # 20568 - BLACK) & (PART # 20568S - BLACK W/ RED TRIM)



2009-Present BMW 7-Series (F02)
(PART # 30208 - BLACK)



2002-2008 BMW 7-Series (E65/66)
(PART # 30669 - BLACK)



2007-Present BMW X5 (E70)
(PART # 30708 - BLACK)



2009-Present Mercedes-Benz E-Class (C207)
(PART # 10009 - BLACK)



2005-Present Mercedes-Benz S-Class (W221)
(PART # 10008 - BLACK)



2010-Present Mercedes-Benz E-Class (W212)
(PART # 15008 - BLACK)



2001-2006 Mini (R50/R53S)
(PART # 20508 - BLACK)



2007-Present Nissan GTR (R35)
(PART # 20008 - BLACK)



2010-Present Volkswagen Golf (MK6) & Scirocco
(PART # 40608S - BLACK W/ RED TRIM)



2010-Present Volkswagen Golf (MK6) & Scirocco
(PART # 40608 - BLACK)

“Posh Pile® VW Golf Mark VI mats are the best car mats money can buy.”

Mr. Gene Kwee (Singapore)



5TH AVENUE™ MPV MATS



The thickest luxurious posh carpet pile



Waterproof rubber non-skid backing

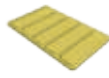

Premium long-wearing nylon heel pad



Exclusive OE style woven edge



UV and stain resistant

If you drive an Alphard, Elgrand, Stepwgn, Serena, Stream, Previa, Vellfire, or similar vehicle, and want the very plushest carpet mats, choose:



2nd Row MPV Mat
(Part # 02008 - BLACK)



3rd Row MPV Mat
(Part # 03008 - BLACK)

Weather Fortress™ for the 1st row driver and passenger:



Weather Fortress™ mats in a 2010 Toyota Vellfire



Weather Fortress™ mats in a 2010 Toyota Vellfire

5TH Avenue™ Luxury 2nd Row MPV mat for the 2nd row:

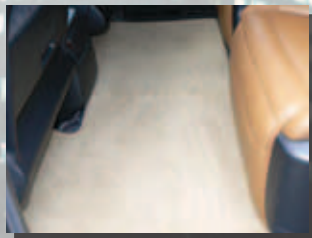

5TH Avenue™ 2nd Row MPV in a 2010 Toyota Vellfire

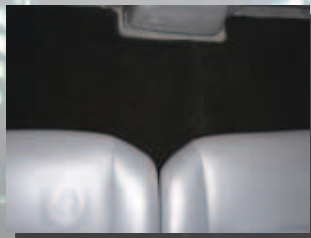

5TH Avenue™ 2nd Row MPV in a 2006 Toyota Alphard



5TH Avenue™ 2nd Row MPV in a 2011 Toyota Previa

5TH Avenue™ Luxury 3rd Row MPV mat for the 3rd row:



5TH Avenue™ 3rd Row MPV in a 2006 Toyota Alphard



5TH Avenue™ 3rd Row MPV in a 2011 Toyota Previa



5TH Avenue™ 3rd Row MPV in a 2012 Honda Odyssey



PACIFIC COAST HIGHWAY™ UNIVERSAL LUXURY CAR MATS

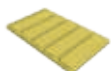

Premium long-wearing nylon heel pad



Waterproof rubber non-skid backing



UV and stain resistant



Exclusive OE style woven edge



GREY
5 PIECE SET
PART # 60507



TAN/BEIGE
5 PIECE SET
PART # 60509



BLACK
5 PIECE SET
PART # 60508

- 5 Piece carpet set
- Full 18oz. needle punch pile
- Quality non-skid waterproof backing
- Superior woven edging
- Only 'value' priced floor mats with luxury features and appearance!

Superior Quality Universal Mat Set



Posh Pile® Pacific Coast Highway™ mats in a 2008 Honda Civic



Posh Pile® Pacific Coast Highway™ mats in a 2009 Toyota Ractis

Pacific Coast Highway™ Gallery



Pacific Coast Highway™ in a 2012 Jeep Grand Cherokee



Pacific Coast Highway™ in a 2009 Ford Escape



Pacific Coast Highway™ in a 2012 KIA Forte/ Cerato



Pacific Coast Highway™ in a 2008 Honda CRV



Pacific Coast Highway™ in a 2012 KIA Sorento



Pacific Coast Highway™ in a 2012 Nissan Juke

“LOVE THEM”

Posh Pile® US Customer

OUR LUXURY MAT!



WWW.POSHPILE.COM

STAY TUNED™ HIGH PERFORMANCE CAR MATS



Innovative weight saving hook anti-drift backing



Super sound deadening design



Unique tufted premium posh carpet pile

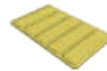

Premium long-wearing nylon heel pad



Exclusive woven edge



BLACK
5 PIECE SET
PART # 70508



TAN/BEIGE
5 PIECE SET
PART # 70509

- World's first high performance floor mats
- 60% lighter than OE replacement mats
- Unique hook 'anti-drift' backing
- Significant noise dampening quality
- Highest quality tufted posh pile
- Unique sculpted design
- 5 piece carpet mat set
- Exclusive edge and nylon woven heel pad
- High performance meets luxury!



Innovative Hook and Loop backing

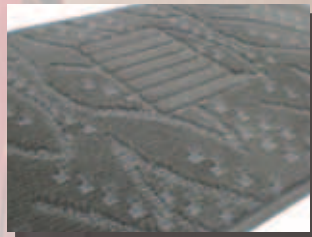

Unique tufted pile

Stay Tuned™ Gallery



Stay Tuned™ in a 2012 Honda CRZ Hybrid



Stay Tuned™ in a 2009 Honda Stream



Stay Tuned™ in a 2012 Lexus IS250



Stay Tuned™ in a 2012 Mitsubishi Lancer



Stay Tuned™ in a 2012 Toyota bB/Scion xB



Stay Tuned™ in a 2012 Honda Civic Si

OUR PERFORMANCE MAT!



WWW.POSHPILE.COM

WEATHER FORTRESS™ SYNTHETIC RUBBER MATS

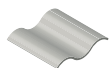

Synthetic rubber for long life



Trimable for a custom fit



Protects from sun, rain, sand, snow



Anti-skid spike prevent mat slipping

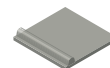

Raised lip keeps spills & liquids off your carpet



BLACK
4 PIECE SET
PART # 070478



TAN/BEIGE
4 PIECE SET
PART # 070479



GREY
4 PIECE SET
PART # 070477

- Fits 99% of vehicles on the road today
- Trimmable 17 different places
- Made of durable, high-quality synthetic rubber
- Equipped with rubber spiked backing to prevent mats from sliding
- Resistant to water, mud, chemicals, and harmful UV light
- Can be used as a 'top mat' to protect your carpet mats
- 3 colors to match today's interiors

Also available in:



2 Piece Set - Rear
TAN/BEIGE - Part # 070279



Long Rear Mat
BLACK - Part # 070378



2 Piece Set - Front
BLACK - Part # 070178

Weather Fortress™ Gallery



Weather Fortress™
in a 2012
Lamborghini
Gallardo



Weather Fortress™
in a 2011 Mercedes-
Benz R350



Weather Fortress™
in a 2011 Subaru
WRX STI



Weather Fortress™
in a 2012 Audi S5



Weather Fortress™
in a 2011 Lexus
IS250

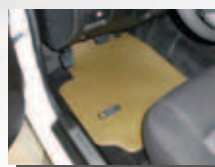

Weather Fortress™
in a 2012 GMC
Canyon/Chevrolet
Colorado

"GREAT MATS!! THANKS!!"

Posh Pile® US Customer

OUR RAIN MAT!



WEATHER FORTRESS™ PREMIUM SYNTHETIC RUBBER MATS

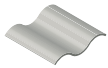

Synthetic rubber for long life



Trimmable for a custom fit



Protects from sun, rain, sand, snow



Anti-skid spike prevent mat slipping

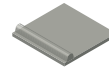

Raised lip keeps spills & liquids off your carpet



TAN/BEIGE
2 PIECE SET
PART # 080179



BLACK
2 PIECE SET
PART # 080178



GREY
2 PIECE SET
PART # 080177

- Heavy synthetic rubber for long life
- Trimmable for a custom fit
- Protection from sun, rain, sand, snow
- Large anti-skid spikes prevent mat slipping
- Higher raised lip keeps spills and liquids off your carpet
- Ideal for cold climates & heavy duty use

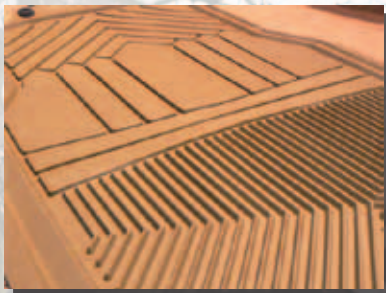

Heavy duty long wearing synthetic rubber!



Weather Fortress™ Premium 4 Piece Set
PART # 080478

Weather Fortress™ Premium Gallery



Weather Fortress™ Premium in a 2008 Chevrolet Corvette



Weather Fortress™ Premium in a 2007 Porsche Cayenne



Weather Fortress™ Premium in a 2005 Jeep Wrangler



Weather Fortress™ Premium in a 2011 Lexus IS250



Weather Fortress™ Premium in a 2005 Chrysler Pacifica



Weather Fortress™ Premium in a 2007 Volvo XC90

"LOVE THESE MATS!!! THANKS! A++++++"
Posh Pile® US Customer

OUR ALL WEATHER MAT!



WEATHER FORTRESS™ TRUNK/BOOT MAT

- Made of the highest quality synthetic rubber
- Tough, heavy duty abrasion resistant design
- Resistant to high and low temperatures
- Unique 'Diamond Plate' design stops your cargo from sliding
- Trimmable to fit hundreds of cars, SUV's, and MPV's



Weather Fortress™ Trunk/Boot mat in a 1996 BMW 5-Series
BLACK (PART # 090678)

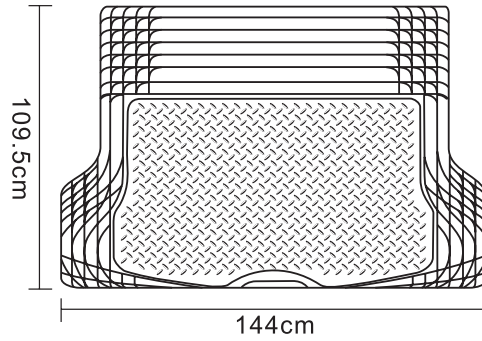

Universal Fit
144cm x 109.5cm / 56.69" x 43.11"

Weather Fortress™ Trunk/Boot Mat Gallery



Weather Fortress™ Trunk/Boot mat in a 2012 KIA Sorento



Weather Fortress™ Trunk/Boot mat in a 2011 Porsche Cayenne



Weather Fortress™ Trunk/Boot mat in a 2011 Subaru WRX STI



Weather Fortress™ Trunk/Boot mat in a 2005 Chrysler Pacifica



Weather Fortress™ Trunk/Boot mat in a 2011 Toyota Vellfire

PROTECT YOUR CARGO AREA!



MAKE	TYPE	YEAR FROM	YEAR TO	5TH AVENUE	STAY TUNED	PACIFIC COAST HIGHWAY	DIRECT FIT MAT	WEATHER FORTRESS	WEATHER FORTRESS PREMIUM	WEATHER FORTRESS TRUNK/BOOT MAT
ACURA										
Integra	2DR	2002	2006	8050	7050	6050	NA	Fit	Fit	9067
TSX	4DR	2009	2012	8050	7050	6050	NA	Fit	Fit	9067
ALFA ROMEO										
147	4DR	2001	2010	8050	7050	6050	NA	Fit	Fit	9067
156	4DR	1997	2007	8050	7050	6050	NA	Fit	Fit	9067
159	4DR	2005	2011	8050	7050	6050	NA	Fit	Fit	9067
Breva	2DR	2005	2011	8050	7050	6050	NA	Fit	Fit	9067
GT	2DR	2004	2010	8050	7050	6050	NA	Fit	Fit	9067
AUDI										
A1	2DR	2010	2012	8050	7050	6050	NA	Fit	Fit	9067
A4	4DR	2001	2012	8050	7050	6050	NA	Fit	Fit	9067
A4 Avant	WAGON	2009	2012	8050	7050	6050	NA	Fit	Fit	9067
A5	2DR	2007	2011	8050	7050	6050	NA	Fit	Fit	9067
A5 Sportback	4DR	2009	2011	8050	7050	6050	NA	Fit	Fit	9067
A6	4DR	2005	2012	8050	7050	6050	NA	Fit	Fit	9067
A6 Avant	WAGON	2004	2012	8050	7050	6050	NA	Fit	Fit	9067
A7	2DR	2012	2012	8050	7050	6050	NA	Fit	Fit	9067
A8	4DR	2003	2009	8050	7050	6050	NA	Fit	Fit	9067
Q5	CRX	2009	2012	8050	7050	6050	NA	Fit	Fit	9067
Q7	CRX	2006	2012	8050	7050	6050	NA	Fit	Fit	9067
R8	2DR	2007	2012	NA	NA	NA	NA	Fit	NA	NA
S4	4DR	2009	2011	8050	7050	6050	NA	Fit	Fit	9067
S5	2DR	2007	2011	8050	7050	6050	NA	Fit	Fit	9067
TT	2DR	2009	2012	NA	NA	NA	18022	Fit	NA	9067
BMW										
128i	2DR	2008	2012	NA	NA	NA	NA	Fit	NA	9067
3-Series (E46/E90)	4DR	1998	2011	NA	NA	NA	3090	Fit	NA	9067
5-Series (E60)	4DR	2004	2009	NA	NA	NA	3060	Fit	NA	9067
7-Series (E66)	4DR	2002	2008	NA	NA	NA	3066	Fit	NA	9067
7-Series (F02)	4DR	2009	2012	NA	NA	NA	3020	Fit	NA	9067
750	4DR	2006	2008	NA	NA	NA	NA	Fit	NA	9067
X3	CRX	2003	2010	NA	NA	NA	NA	Fit	NA	9067
X5/X5M (E70)	CRX	2007	2011	NA	NA	NA	3070	Fit	NA	9067
Z4	2DR	2009	2012	NA	NA	NA	NA	Fit	NA	NA
CITROEN										
C5	4DR	2009	2011	8050	7050	6050	NA	Fit	Fit	9067
DAEWOO										
Lancetti	4DR	2008	2012	8050	7050	6050	NA	Fit	Fit	9067
DAIHATSU										
Charade	4DR	2000	2005	8050	7050	6050	NA	Fit	Fit	9067
Copen	2DR	2002	2011	8050	7050	6050	NA	Fit	Fit	NA

Color guide: add 7 for grey, 8 for black, 9 for tan. For example 8050 is 5th Avenue, 80507 is grey, 80508 is black, 80509 is tan



MAKE	TYPE	YEAR FROM	YEAR TO	5TH AVENUE	STAY TUNED	PACIFIC COAST HIGHWAY	DIRECT FIT MAT	WEATHER FORTRESS	WEATHER FORTRESS PREMIUM	WEATHER FORTRESS TRUNK/BOOT MAT
DAIHATSU										
GrandMove	MPV	1996	2002	8050	7050	6050	NA	Fit	Fit	9067
Materia	4DR	2006	2011	8050	7050	6050	NA	Fit	Fit	9067
Mira Gino	4Dr	1999	2009	8050	7050	6050	NA	Fit	Fit	9067
Move	4DR	2003	2012	8050	7050	6050	NA	Fit	Fit	9067
Naked	4DR	2000	2004	8050	7050	6050	NA	Fit	Fit	9067
Sirion	4DR	1998	2004	8050	7050	6050	NA	Fit	Fit	9067
Terios	SUV	2006	2012	8050	7050	6050	NA	Fit	Fit	9067
YRV	MPV	2000	2005	8050	7050	6050	NA	Fit	Fit	9067
DODGE										
Grand Caravan	MPV	1996	2007	8050	7050	6050	NA	Fit	Fit	9067
FORD										
Escape	SUV	2008	2012	8050	7050	6050	NA	Fit	Fit	9067
Focus	4DR	2008	2012	8050	7050	6050	NA	Fit	Fit	9067
Laser Lynx	4DR	1994	1998	8050	7050	6050	NA	Fit	Fit	9067
Mondeo	4DR	1993	2012	8050	7050	6050	NA	Fit	Fit	9067
S-Max (Fit front two rows)	MPV	2006	2012	8050	7050	6050	NA	Fit	Fit	9067
HONDA										
Accord Euro/Spirior	4DR	2008	2012	8050	7050	6050	NA	Fit	Fit	9067
Airwave	4DR	2005	2011	8050	7050	6050	NA	Fit	Fit	9067
City	4DR	2008	2012	8050	7050	6050	NA	Fit	Fit	9067
Civic	4DR	1996	2012	8050	7050	6050	NA	Fit	Fit	9067
CRV	4DR	2007	2012	8050	7050	6050	NA	Fit	Fit	9067
Edix	4DR	2004	2009	8050	7050	6050	NA	Fit	Fit	9067
Elysion	MPV	2004	2011	8050	7050	6050	NA	Fit	Fit	9067
FR-V	MPV	2004	2009	8050	7050	6050	NA	Fit	Fit	9067
Jazz/Fit	MPV	2002	2012	8050	7050	6050	NA	Fit	Fit	9067
Odyssey	MPV	2003	2012	8050	7050	6050	NA	Fit	Fit	9067
Spike	4DR	2002	2008	8050	7050	6050	NA	Fit	Fit	9067
Stepwgn	MPV	2005	2009	8050	7050	6050	NA	Fit	Fit	9067
Stepwgn 2nd Row	MPV	2005	2009	0200	NA	NA	NA	07027	NA	NA
Stepwgn 3rd Row	MPV	2005	2009	0300	NA	NA	NA	NA	NA	NA
Stream	4DR	2001	2012	8050	7050	6050	NA	Fit	Fit	9067
Stream 2nd Row	4DR	2001	2012	0200	NA	NA	NA	07027	NA	NA
Stream 3rd Row	4DR	2001	2012	0300	NA	NA	NA	NA	NA	NA
HYUNDAI										
Avante/Elantra	WAGON	2007	2011	8050	7050	6050	NA	Fit	Fit	9067
Azera	4DR	2005	2011	8050	7050	6050	NA	Fit	Fit	9067
Getz	4DR	2002	2011	8050	7050	6050	NA	Fit	Fit	9067
i10	4DR	2007	2011	8050	7050	6050	NA	Fit	Fit	9067
i30	4DR	2007	2012	8050	7050	6050	NA	Fit	Fit	9067
Matrix	4DR	2001	2010	8050	7050	6050	NA	Fit	Fit	9067
Sonata	4DR	2004	2008	8050	7050	6050	NA	Fit	Fit	9067
Tucson	CRX	2005	2012	8050	7050	6050	NA	Fit	Fit	9067



MAKE	TYPE	YEAR FROM	YEAR TO	5TH AVENUE	STAY TUNED	PACIFIC COAST HIGHWAY	DIRECT FIT MAT	WEATHER FORTRESS	WEATHER FORTRESS PREMIUM	WEATHER FORTRESS TRUNK/BOOT MAT
INFINITI										
G37	2DR	2008	2011	8050	7050	6050	NA	Fit	Fit	9067
M37	4DR	2011	2012	8050	7050	6050	NA	Fit	Fit	9067
JAGUAR										
S-Type	4DR	1999	2009	8050	7050	6050	NA	Fit	Fit	9067
XF	4DR	2008	2012	8050	7050	6050	NA	Fit	Fit	9067
KIA										
Cerato	4DR	2003	2011	8050	7050	6050	NA	Fit	Fit	9067
Forte	4DR	2008	2012	8050	7050	6050	NA	Fit	Fit	9067
Morning	4DR	2005	2005	8050	7050	6050	NA	Fit	Fit	9067
Rio (hatchback)	2DR	2000	2002	8050	7050	6050	NA	Fit	Fit	9067
Shuma	4DR	2008	2010	8050	7050	6050	NA	Fit	Fit	9067
Sorento	CRX	2009	2012	8050	7050	6050	NA	Fit	Fit	9067
Spectra	4DR	2003	2011	8050	7050	6050	NA	Fit	Fit	9067
Sportage	SUV	1993	2012	8050	7050	6050	NA	Fit	Fit	9067
LAND ROVER										
Discovery	SUV	2008	2012	8050	7050	6050	NA	Fit	Fit	9067
Freelander/LR2	CRX	1997	2012	8050	7050	6050	NA	Fit	Fit	9067
LEXUS										
ES300	4DR	1996	2005	8050	7050	6050	NA	Fit	Fit	9067
IS200	4DR	1998	2011	8050	7050	6050	NA	Fit	Fit	9067
IS250/IS350	4DR	2006	2011	8050	7050	6050	NA	Fit	Fit	9067
IS250C	2DR	2006	2012	8050	7050	6050	NA	Fit	Fit	9067
IS300	4DR	2000	2006	8050	7050	6050	NA	Fit	Fit	9067
LS430/460	4DR	2001	2012	8050	7050	6050	NA	Fit	Fit	9067
RX350	CRX	2004	2012	8050	7050	6050	NA	Fit	Fit	9067
RX450h	CRX	2004	2012	8050	7050	6050	NA	Fit	Fit	9067
SC430	2DR	2002	2011	8050	7050	6050	NA	Fit	Fit	NA
MAZDA										
3/323	4DR	1999	2011	8050	7050	6050	NA	Fit	Fit	9067
6	4DR	2002	2008	8050	7050	6050	NA	Fit	Fit	9067
Mazda 2	4DR	2007	2009	8050	7050	6050	NA	Fit	Fit	9067
Mazda CX-7	4DR	2007	2011	8050	7050	6050	NA	Fit	Fit	9067
Miata / MX-5	2DR	1989	2011	8050	7050	6050	NA	Fit	Fit	NA
MPV/8 (Fit front two rows)	MPV	1999	2011	8050	7050	6050	NA	Fit	Fit	9067
MERCEDES-BENZ										
B-Class	4DR	2005	2011	8050	7050	6050	NA	Fit	Fit	9067
C-Class	4DR	2007	2012	NA	NA	NA	NA	Fit	Fit	9067
E-Class	4DR	2010	2012	NA	NA	NA	NA	Fit	Fit	9067
E-Class Coupe	2DR	2010	2012	NA	NA	NA	NA	Fit	Fit	9067
E-Class (C207)	2DR	2009	2012	NA	NA	NA	1200	Fit	NA	9067
E-Class (W212)	4DR	2009	2012	NA	NA	NA	1500	Fit	NA	9067



MAKE	TYPE	YEAR FROM	YEAR TO	5TH AVENUE	STAY TUNED	PACIFIC COAST HIGHWAY	DIRECT FIT MAT	WEATHER FORTRESS	WEATHER FORTRESS PREMIUM	WEATHER FORTRESS TRUNK/BOOT MAT
MERCEDES-BENZ										
G-Wagon	SUV	1990	2012	NA	NA	NA	NA	Fit	Fit	9067
GL-Class	CRX	2007	2012	NA	NA	NA	NA	Fit	Fit	9067
M-Class	SUV	2006	2012	8050	7050	6050	NA	Fit	Fit	9067
R-Class	CRX	2006	2012	8050	7050	6050	NA	Fit	Fit	9067
S-Class	4DR	2006	2012	NA	NA	NA	NA	Fit	NA	9067
S-Class (W221)	4DR	2005	2012	NA	NA	NA	1000	Fit	NA	9067
SL-Class	2DR	2008	2011	NA	NA	NA	NA	Fit	Fit	NA
SLK	2DR	2004	2012	8050	7050	6050	NA	Fit	Fit	NA
SLS AMG	2DR	2011	2012	NA	NA	NA	NA	Fit	Fit	NA
MINI										
Cooper (R50/R53S)	2DR	2001	2006	NA	NA	NA	2050	Fit	NA	NA
Cooper (R56)	2DR	2007	2011	NA	NA	NA	2056	Fit	NA	NA
MITSUBISHI										
Colt	4DR	1996	2011	8050	7050	6050	NA	Fit	Fit	9067
Grandis	MPV	2003	2012	8050	7050	6050	NA	Fit	Fit	9067
Lancer / Lancer Evolution	4DR	1998	2012	8050	7050	6050	NA	Fit	Fit	9067
Outlander	CRX	2005	2012	8050	7050	6050	NA	Fit	Fit	9067
Pajero	SUV	2006	2008	8050	7050	6050	NA	Fit	Fit	9067
NISSAN										
350Z/370Z	2DR	2003	2012	8050	7050	6050	NA	Fit	Fit	NA
Cefiro	4DR	2003	2011	8050	7050	6050	NA	Fit	Fit	9067
Elgrand	MPV	1997	2012	NA	NA	NA	NA	Fit	Fit	Fit
Elgrand 2nd Row	MPV	1997	2012	0200	NA	NA	NA	07027	NA	NA
Elgrand 3rd Row	MPV	1997	2012	0300	NA	NA	NA	NA	NA	NA
Grand Livina	MPV	2006	2006	8050	7050	6050	NA	Fit	Fit	9067
GTR (R35)	2DR	2008	2012	NA	NA	NA	2000	Fit	NA	9067
Impul	4DR	2003	2011	8050	7050	6050	NA	Fit	Fit	9067
Latio	4DR	2004	2011	8050	7050	6050	NA	Fit	Fit	9067
March	4DR	2002	2012	8050	7050	6050	NA	Fit	Fit	9067
Murano	CRX	2007	2012	8050	7050	6050	NA	Fit	Fit	9067
Note	4DR	2004	2009	8050	7050	6050	NA	Fit	Fit	9067
Presage	MPV	2003	2007	8050	7050	6050	NA	Fit	Fit	9067
Quest	MPV	2011	2011	8050	7050	6050	NA	Fit	Fit	9067
Rogue	CRX	2008	2012	8050	7050	6050	NA	Fit	Fit	9067
Serena	MPV	2007	2012	NA	NA	NA	NA	Fit	Fit	9067
Serena 2nd Row	MPV	2007	2012	0200	NA	NA	NA	07027	NA	NA
Serena 3rd Row	MPV	2007	2012	0300	NA	NA	NA	NA	NA	NA
Sunny	4DR	1998	2012	8050	7050	6050	NA	Fit	Fit	9067
Sylphy	4DR	2006	2011	8050	7050	6050	NA	Fit	Fit	9067
Teana	4DR	2003	2012	8050	7050	6050	NA	Fit	Fit	9067
Tida	4DR	2004	2009	8050	7050	6050	NA	Fit	Fit	9067
Versa	4DR	2007	2012	8050	7050	6050	NA	Fit	Fit	9067



MAKE	TYPE	YEAR FROM	YEAR TO	5TH AVENUE	STAY TUNED	PACIFIC COAST HIGHWAY	DIRECT FIT MAT	WEATHER FORTRESS	WEATHER FORTRESS PREMIUM	WEATHER FORTRESS TRUNK/BOOT MAT
OPEL										
Astra	4DR	2004	2012	8050	7050	6050	NA	Fit	Fit	9067
PERODUA										
Kembara	4DR	2006	2006	8050	7050	6050	NA	Fit	Fit	9067
Kenari	4DR	2003	2011	8050	7050	6050	NA	Fit	Fit	9067
Myvi	2DR	2005	2011	8050	7050	6050	NA	Fit	Fit	NA
VivaEzi	2DR	2006	2007	8050	7050	6050	NA	Fit	Fit	NA
PEUGEOT										
206	4DR	1999	2006	8050	7050	6050	NA	Fit	Fit	9067
206CC	2DR	2008	2012	8050	7050	6050	NA	Fit	Fit	NA
307	4DR	2001	2008	8050	7050	6050	NA	Fit	Fit	9067
307SW	WAGON	2001	2011	8050	7050	6050	NA	Fit	Fit	9067
308SW	WAGON	1995	2007	8050	7050	6050	NA	Fit	Fit	9067
405	4DR	1997	2004	8050	7050	6050	NA	Fit	Fit	9067
406	4DR	1996	2012	8050	7050	6050	NA	Fit	Fit	9067
408	4DR	2010	2012	8050	7050	6050	NA	Fit	Fit	9067
PORSCHE										
911 (996)	2DR	1998	2005	NA	NA	NA	16024	NA	NA	NA
Boxster (986)	2DR	1996	2004	NA	NA	NA	9000	NA	NA	NA
Boxster	2DR	2005	2012	NA	NA	NA	NA	Fit	NA	NA
Cayenne	CRX	2003	2007	8050	7050	6050	NA	Fit	Fit	9067
Cayman	2DR	2006	2012	NA	NA	NA	NA	Fit	NA	NA
Panamera	4DR	2010	2012	8050	7050	6050	NA	Fit	Fit	9067
PROTON										
Exora(Fit front two rows)	MPV	2009	2011	8050	7050	6050	NA	Fit	Fit	9067
Gen2	4DR	2004	2011	8050	7050	6050	NA	Fit	Fit	9067
Persona	4DR	2007	2011	8050	7050	6050	NA	Fit	Fit	9067
Satria	4DR	2006	2011	8050	7050	6050	NA	Fit	Fit	9067
Savvy	4DR	2005	2011	8050	7050	6050	NA	Fit	Fit	9067
Waja	4DR	2000	2006	8050	7050	6050	NA	Fit	Fit	9067
Wira	4DR	1993	2007	8050	7050	6050	NA	Fit	Fit	9067
Altima	4DR	2002 - 2012	8050	7050	6050	NA	Fit	Fit	9067	
RENAULT										
Kangoo	WAGON	1997	2011	8050	7050	6050	NA	Fit	Fit	9067
Laguna	2DR	2007	2011	8050	7050	6050	NA	Fit	Fit	9067
SAAB										
9-3	4DR	2002	2011	8050	7050	6050	NA	Fit	Fit	9067
93X	4DR	2010	2011	8050	7050	6050	NA	Fit	Fit	9067
SUBARU										
Forester	WAGON	2008	2012	8050	7050	6050	NA	Fit	Fit	9067
Impreza	4DR	2007	2012	8050	7050	6050	NA	Fit	Fit	9067



MAKE	TYPE	YEAR FROM	YEAR TO	5TH AVENUE	STAY TUNED	PACIFIC COAST HIGHWAY	DIRECT FIT MAT	WEATHER FORTRESS	WEATHER FORTRESS PREMIUM	WEATHER FORTRESS TRUNK/BOOT MAT
SUBARU										
Impreza WRX	4DR	2001	2012	8050	7050	6050	NA	Fit	Fit	9067
Legacy	4DR	2010	2012	8050	7050	6050	NA	Fit	Fit	9067
Pleo	4DR	1998	2012	8050	7050	6050	NA	Fit	Fit	9067
R1	4DR	2005	2012	8050	7050	6050	NA	Fit	Fit	9067
R2	4DR	2003	2012	8050	7050	6050	NA	Fit	Fit	9067
SUZUKI										
Every/Carry	MPV	2003	2012	8050	7050	6050	NA	Fit	Fit	9067
Grand Vitara	SUV	2008	2012	8050	7050	6050	NA	Fit	Fit	9067
Jimny	SUV	1998	2009	8050	7050	6050	NA	Fit	Fit	9067
KEI	SUV	1998	2011	8050	7050	6050	NA	Fit	Fit	9067
Kizashi	4DR	2009	2012	8050	7050	6050	NA	Fit	Fit	9067
Swift	4DR	2004	2012	8050	7050	6050	NA	Fit	Fit	9067
Wagon R	WAGON	1998	2012	8050	7050	6050	NA	Fit	Fit	9067
TOYOTA										
Alphard	MPV	2002	2012	NA	NA	NA	NA	Fit	Fit	Fit
Alpard 2nd Row	MPV	2002	2012	0200	NA	NA	NA	07027	NA	NA
Alpard 3rd Row	MPV	2002	2012	0300	NA	NA	NA	NA	NA	NA
Camry	4DR	2002	2012	8050	7050	6050	NA	Fit	Fit	9067
Celica	2DR	1999	2006	8050	7050	6050	NA	Fit	Fit	9067
Corolla / Altis	4DR	2001	2012	8050	7050	6050	NA	Fit	Fit	9067
Corolla Ex	4DR	2001	2012	8050	7050	6050	NA	Fit	Fit	9067
Crown	4DR	2001	2012	8050	7050	6050	NA	Fit	Fit	9067
EchoVerso	4DR	1999	2012	8050	7050	6050	NA	Fit	Fit	9067
Estima	MPV	2000	2012	8050	7050	6050	NA	Fit	Fit	9067
Estima 2nd Row	MPV	2000	2012	0200	NA	NA	NA	07027	NA	NA
Estima 3rd Row	MPV	2000	2012	0300	NA	NA	NA	NA	NA	NA
Fortuner	SUV	2005	2012	8050	7050	6050	NA	Fit	Fit	9067
Granvia	MPV	1995	2012	8050	7050	6050	NA	Fit	Fit	9067
Granvia 2nd Row	MPV	1995	2012	0200	NA	NA	NA	07027	NA	NA
Granvia 3rd Row	MPV	1995	2012	0300	NA	NA	NA	NA	NA	NA
Highlander	CRX	2000	2012	8050	7050	6050	NA	Fit	Fit	9067
Hilux Vigo	TRUCK	2006	2012	8050	7050	6050	NA	Fit	Fit	9067
Ipsum/Picnic (Fit front two rows)	MPV	1995	2012	8050	7050	6050	NA	Fit	Fit	9067
Isis	MPV	2004	2011	8050	7050	6050	NA	Fit	Fit	9067
Land-Cruiser	SUV	2008	2012	8050	7050	6050	NA	Fit	Fit	9067
Mark-X ZIO	4DR	2004	2007	8050	7050	6050	NA	Fit	Fit	9067
Matrix	4DR	2003	2007	8050	7050	6050	NA	Fit	Fit	9067
MR-2	2DR	2000	2007	8050	7050	6050	NA	Fit	Fit	NA
Porte	2DR	2005	2009	8050	7050	6050	NA	Fit	Fit	9067
Prado	SUV	2002	2012	8050	7050	6050	NA	Fit	Fit	9067
Previa / Sienna	MPV	2006	2009	8050	7050	6050	NA	Fit	Fit	9067
Previa/Sienna 2nd Row	MPV	2006	2009	0200	NA	NA	NA	07027	NA	NA
Previa/Sienna 3rd Row	MPV	2006	2009	0300	NA	NA	NA	NA	NA	NA



MAKE	TYPE	YEAR FROM	YEAR TO	5TH AVENUE	STAY TUNED	PACIFIC COAST HIGHWAY	DIRECT FIT MAT	WEATHER FORTRESS	WEATHER FORTRESS PREMIUM	WEATHER FORTRESS TRUNK/BOOT MAT
TOYOTA										
Prius	4DR	2004	2012	8050	7050	6050	NA	Fit	Fit	9067
Ractis	4DR	2005	2012	8050	7050	6050	NA	Fit	Fit	9067
Reiz	4DR	2009	2012	8050	7050	6050	NA	Fit	Fit	9067
Sienta	MPV	2003	2007	8050	7050	6050	NA	Fit	Fit	9067
Tarago	MPV	2003	2006	8050	7050	6050	NA	Fit	Fit	9067
Unser	4DR	1997	2011	8050	7050	6050	NA	Fit	Fit	9067
Vellfire	MPV	2002	2012	8050	7050	6050	NA	Fit	Fit	9067
Vellfire 2nd Row	MPV	2002	2012	0200	NA	NA	NA	07027	NA	NA
Vellfire 3rd Row	MPV	2002	2012	0300	NA	NA	NA	NA	NA	NA
Vios	4DR	2003	2012	8050	7050	6050	NA	Fit	Fit	9067
Voxy/Noah	MPV	2001	2012	8050	7050	6050	NA	Fit	Fit	9067
Voxy/Noah 2nd Row	MPV	2001	2012	0200	NA	NA	NA	07027	NA	NA
Voxy/Noah 3rd Row	MPV	2001	2012	0300	NA	NA	NA	NA	NA	NA
Wish	WAGON	2003	2012	8050	7050	6050	NA	Fit	Fit	9067
Yaris	4DR	2007	2012	8050	7050	6050	NA	Fit	Fit	9067
VOLKSWAGEN										
Beetle	2DR	1998	2010	8050	7050	6050	NA	Fit	Fit	9067
Caravelle	MPV	2003	2012	8050	7050	6050	NA	Fit	Fit	9067
CC	4DR	2009	2012	NA	NA	NA	NA	Fit	NA	9067
Eos	2DR	2007	2012	NA	NA	NA	NA	Fit	NA	9067
Golf	4DR	1997	2006	8050	7050	6050	NA	Fit	Fit	9067
Golf/GTI (Mk6)	4DR/2DR	2009	2011	NA	NA	NA	40608	Fit	NA	9067
Jetta	4DR	2001	2012	NA	NA	NA	NA	Fit	NA	9067
Jetta Wagon	WAGON	2001	2012	NA	NA	NA	NA	Fit	NA	9067
Magotan	4DR	2003	2006	8050	7050	6050	NA	Fit	Fit	9067
Passat	4DR	2006	2011	NA	NA	NA	NA	Fit	NA	9067
Sagitar	4DR	2006	2008	8050	7050	6050	NA	Fit	Fit	9067
Scirocco	2DR	2008	2012	NA	NA	NA	40608	Fit	NA	9067
Tiguan	CRX	2009	2012	NA	NA	NA	NA	Fit	NA	9067
Touareg	CRX	2002	2004	8050	7050	6050	NA	Fit	Fit	9067
VOLVO										
240	4DR	1974	1993	8050	7050	6050	NA	Fit	Fit	9067
C70	2DR	2006	2012	8050	7050	6050	NA	Fit	Fit	NA
S40	4DR	1995	2009	8050	7050	6050	NA	Fit	Fit	9067
S60	4DR	2000	2002	8050	7050	6050	NA	Fit	Fit	9067
S70	4DR	1997	2012	8050	7050	6050	NA	Fit	Fit	9067
S80	4DR	1998	2012	8050	7050	6050	NA	Fit	Fit	9067
V50	4DR	2003	2012	8050	7050	6050	NA	Fit	Fit	9067
XC60	CRX	2008	2012	8050	7050	6050	NA	Fit	Fit	9067
XC90	CRX	2003	2012	8050	7050	6050	NA	Fit	Fit	9067



TRUNK ORGANIZATION

TRUNK/BOOT STORAGE BAG

- Organizes safety, car cleaning products and tools
- Hook & loop tape included to affix bag securely to trunk
- Removes from trunk and can be carried as a tool bag
- Soft pile protects contents and deadens sound
- "Smart design" fits most cars, trucks, and SUV's
- Available in black or grey to match trunk interiors



BLACK
PART # 00308



GREY
PART # 00307

Dimensions: Length x Height x Depth
20 x 9 x 6.5 inches
50.8 x 22.86 x 16.51 cm

THE PERFECT "TRUNK UPGRADE"!

INTERIOR CARE

12-VOLT CAR VACUUM

- High suction 12-volt motor
- 5 meter (Over 16 ft.) long cord - long enough to stretch from the dashboard to the trunk
- Easy to clean filter
- Adjustable nozzle that gets into small spaces
- Includes a trunk storage bag
- Removes tough dirt



12-VOLT CAR VACUUM
PART # 00100

Unlike conventional rechargeable car vacuums, the Posh Pile® 12-volt vacuum will not lose suction as you clean! Finally a powerful car vacuum!



EXTERIOR CARE

RANDOM ORBITAL POLISHER

- Advanced random orbital motion reduces swirls and paint damage
- Accepts professional 6" foam pads
- Also can be used for applying and removing wax
- 12-volt power with a 5 meter (16.4 feet) cord
- 220-volt power with a 2 meter (6.5 feet) cord
- Bonus: Includes 6" foam pad for polishing and a bonnet for waxing!
(All you need is wax & polish)
- Polish cars, boats, trucks and more!

Available in 12-volt and 220-volt versions!



220-Volt Random
Orbital Polisher
PART # 00220



12-Volt Random
Orbital Polisher
PART # 00200

Includes:



FOAM PAD



MICROFIBER
BONNET

FOAM POLISHING PAD

- Removes swirls and surface imperfections
- Professional quality
- Works with hook and loop fastening system to fit 6" backing plates
- Use with Posh Pile® orbital polishers above



FOAM POLISHING PAD
PART # 00201



EXTERIOR CARE

MICROFIBER WASH GLOVE

- Ergonomic and comfortable in your hand
- Super soft and absorbent
- Safe for paint
- Pampers your paint
- Removable 9" washable microfiber wash glove



MICROFIBER WASH GLOVE
PART # 00252

WASH GLOVE HANDLE

- Fits Posh Pile® 00252 Microfiber Wash Glove to create a wash mop
- Lightweight, soft grip design
- Handle extends from 29" to 49"

Combined with our Microfiber Wash Glove, it's easy to reach any part of your vehicle.



WASH GLOVE HANDLE
PART # 00253

MICROFIBER CAR DUSTER

- Advanced twisted long strand micro fiber technology that safely lifts dust
- 12" lightweight non-breakable composite handle
- Handy storage bag keeps your duster clean
- Will not scratch paint
- For interior and exterior use
- 13" washable microfiber head
- Great for waterless cleaning



MICROFIBER CAR DUSTER
PART # 00250



EXTERIOR CARE

CAR SHAMPOO SPONGE

- Easy to grip
- Holds more soap and water
- Economical/durable
- Porous to lift grime and dirt away from your paint
- The perfect car wash partner!



CAR SHAMPOO SPONGE
PART # 00251

WHEEL SPOKE BRUSH

- Strong and flexible for cleaning hard to reach areas
- Long bristles loosen and remove brake dust, dirt, and grime
- Lightweight with a soft grip handle for ultimate control
- Exclusive lug brush
- Hangable



WHEEL SPOKE BRUSH
PART # 00254

ADVANCED WHEEL FACE BRUSH

- Ergonomic soft rubber grip
- Soft bristles protect the finest wheels/rims
- Bristles designed to stand up to harsh wheel cleaners
- Hangable



WHEEL FACE BRUSH
PART # 00255



RETAIL CENTER

PP-2 RACK

- Welded steel design collapses for easy shipping in one box
- Black powder coating
- Smooth moving wheels
- Double sided Posh Pile® logo header
- Comes with necessary tools & fasteners for installation

Dimensions with Header Card:

Length x Width x Height
 41.5 x 19.75 x 68.75 inches
 105.4 x 50.17 x 174.63 cm

Dimensions without Header Card:

Length x Width x Height
 41.5 x 19.75 x 58.25 inches
 105.4 x 50.17 x 147.96 cm



PP-2 RACK FEATURING POSH PILE® CARPET MATS

PP-2 RACK FEATURING POSH PILE® RUBBER MATS

THE PERFECT RETAIL SHOWCASE!



Ultimate  Luxury



Posh Pile®

Check out our newest products, get the latest news, buy Posh Pile® online.



Facebook

"Like" our page, view our photo albums, communicate with other Posh Pile® owners, and tell us what you think.



Youtube

Watch more than 70 videos and see Posh Pile® products in over 300 vehicles!



Twitter

Get the updates, be the first to hear about new products, and learn what's going on at Posh Pile®.



All About Car Mats blog

www.allaboutcarmats.com
Find the best information about car mats and truthful educational information.



All About Car Detailing blog

www.detail-my-car.com
Learn how to detail your car the professional, and easy, way



www.poshpile.com



www.facebook.com/PoshPile



www.youtube.com/luxuryposhpile



www.twitter.com/poshpile

Find Posh Pile® in: the U.S.A., Canada, Hong Kong, Dubai, Saudi Arabia, Columbia, China, Oman, Malaysia, New Zealand, Singapore, and Thailand

Authorized Distribution Partner:



Unit G, 11/F, Sunview Building, No.3 On Yip Street, Chai Wan, Hong Kong Phone: (852) 2967 - 0202

Posh Pile is a registered trademark and 5TH Avenue, Stay Tuned, Pacific Coast Highway, and Weather Fortress are trademarks of International Market Access Ltd.
© 2012 Posh Pile®