



Ultimate



Luxury

2012-2013 POSH PILE® INTERIOR INNOVATIONS CATALOG

Left Hand Drive Edition

INTRODUCTION

What is Posh Pile®?:

Posh Pile® Ultimate Luxury car mats were created by an avid car enthusiast. He went to hundreds of car shows globally for ten years while launching the leading brand of car care products from the U.S.A. He found his factory mats wore out in one to two years. Because there were no higher quality mats available for car enthusiasts, he created the Posh Pile® brand. Our brand has expanded to offer the very highest quality car mats, interior, and car detailing accessories drawing on our founder's knowledge of car detailing and his quest for the very best!



According to Webster's New World Dictionary, Posh Pile® is defined as:

Posh: adjective: luxurious and fashionable

Pile: a soft, velvety raised surface of yarn loops, often sheared, as on a rug

AT POSH PILE®, WE OFFER:

1. Carpet car mats: Pages 5-8

5TH Avenue is the flagship product of Posh Pile®.

Posh Pile® 5TH Avenue Special Features



Nylon Woven Heel Pad

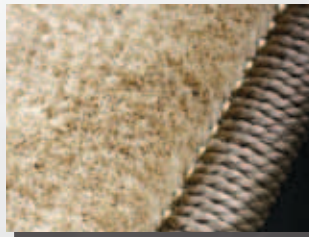

Laser Cutting Sewn Edge



Full Rubber Backing

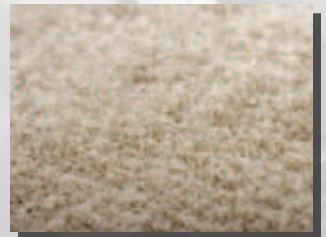

Thickest Posh Pile

2. Synthetic rubber car mats: Pages 9-11

Weather Fortress™ Special Features



Edges can be trimmed for a custom fit



Raised lip to contain moisture



Anti-skid spiked backing



Genuine Weather Fortress emblem



3. Trunk organization: Pages 19

Trunk/Boot Storage Bag Special Features



Soft carpet bags that match your boot perfectly

Weather Fortress™ Trunk/Boot Mat Special Features



Unique diamond plate design ensures your cargo stays put

4. Interior Care: Pages 19

12-Volt Car Vacuum Special Features



Long lasting high power not found in rechargeables

5. Exterior Care: Pages 20-21

12-Volt & 220-Volt Random Orbital Polisher Special Features



A complete swirl removal system, just add chemicals

Foam Polishing Pad Special Features



Professional grade hook and loop fastening system

Microfiber Car Duster Special Features



Attracts dirt and dust to clean safely

Microfiber Wash Glove Special Features



Great for your hand, safe for your paint

Wash Glove Handle Special Features



Turns the Wash Glove into a clean anywhere tool

Car Shampoo Sponge Special Features



A quality sponge that is an amazing value

Wheel Spoke Brush Special Features



Unique Posh Pile® design cleans all the nooks and crannies

Advanced Wheel Face Brush Special Features



Unique Posh Pile® design pampers your wheels



FREQUENTLY ASKED QUESTIONS

How can I know if Posh Pile® mats will fit my car?

Posh Pile® has an application guide on pages 12 to 18. For the latest up-to-date version, log on to our website at: www.poshpile.com.

- Our universal carpet mats fit **over 90%** of vehicles tested
- Our Weather Fortress™ rubber mats fit **over 99%** of vehicles tested

Please understand that universal mats are designed to fit the majority of passenger cars, MPVs, light trucks, and SUVs. As such, they are a compromise and in some cases they can be a bit narrower than the original factory mat.

Do I need universal or direct fit mats for my car?

The truthful answer is: *it depends.*

If you have a car with a floor mounted accelerator pedal like a Mini or most BMWs, then you need a direct fit mat.

- Over 80% of today's cars have the accelerator, brake pedal, and clutch hanging from the dashboard, so universal mats with the right "cut" can fit most cars nicely.

If you have a typical two or four door passenger car, most likely, a universal mat will fit your car.

- Universal mats can save you anywhere from 30-80% compared to the cost of direct fit mats from a car dealer!

Two Examples:

Dashboard mounted gas pedal



Posh Pile® Universal Mats in a 2012 Audi A6

Floor mounted gas pedal



Posh Pile® Direct Fit Mats in a 2010 Mini Cooper (R56)

Why use Posh Pile® mats?

Our mats will upgrade your interior by offering a thick, new luxury look. They also protect your interior from grease, oil, road tar, and even wear and tear.



There's three types of Posh Pile® carpet mats, what's the difference?



5TH Avenue™
Our very best, most luxurious car mat



Pacific Coast Highway™
Our full-featured luxury mat at a value price



Stay Tuned™
Innovative hook and loop mat pioneered in Japan for high performance & better fuel economy

Why do rubber car mats smell?

Real rubber smells, but most rubber car mats aren't actually made of rubber. PVC is the most common material, which sometimes can have a really strong odor. Posh Pile® mats do not have any bad rubber smell because they're made of advanced TPR, thermoplastic rubber.

What makes the best rubber mat?

It's all about the material. PVC is the lowest quality, while synthetic rubber materials like TPR (thermoplastic rubber) are the highest quality available for rubber mats.

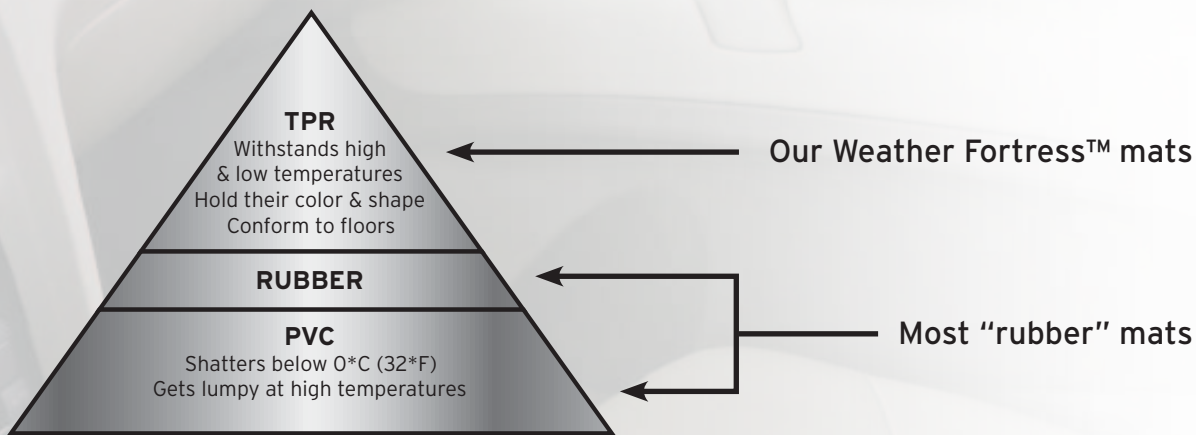

How do I trim my Weather Fortress™ mats?

Simply use a pair of scissors to trim just outside of the secondary raised lip for a great looking custom fit mat!



For more FAQ's, check out our website: www.poshpile.com



5TH AVENUE™ ULTIMATE LUXURY MATS



The thickest luxurious posh carpet pile



Waterproof rubber non-skid backing

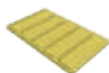

Premium long-wearing nylon heel pad



Exclusive OE style woven edge



UV and stain resistant



TAN/BEIGE
5 PIECE SET
PART # 81509



GREY
5 PIECE SET
PART # 81507



BLACK
5 PIECE SET
PART # 81508

- Rubber waterproof non-skid backing for long, dependable life
- 5 piece carpet set
- Thickest quality mats available
- Premium long wearing nylon heel pad
- High quality woven edges
- UV and stain resistant

Our flagship product!



Posh Pile® 5TH Avenue™ Mats in a 2012 Buick Verano



Posh Pile® 5TH Avenue™ Mats in a 2012 Chevy Impala

5TH Avenue™ Gallery



5TH Avenue™ in a 2013 Cadillac XTS



5TH Avenue™ in a 2012 Audi A8



5TH Avenue™ in a 2012 Dodge Charger



5TH Avenue™ in a 2012 GMC Canyon



5TH Avenue™ in a 2012 Lamborghini Murcielago



5TH Avenue™ in a 2012 Ford Focus

“Wow these mats are the BOMB! You cannot buy a more plush mat”

Posh Pile® US Customer

OUR LUXURY MAT!



5TH AVENUE™ MPV MATS



The thickest luxurious posh carpet pile



Waterproof rubber non-skid backing

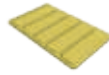

Premium long-wearing nylon heel pad



Exclusive OE style woven edge



UV and stain resistant

If you drive a Honda Odyssey, Ford F-150, Nissan Armada, GMC Conversion Van, or similar large vehicle, and want the very plushest carpet mats, choose:



2nd Row MPV Mat
(Part # 02008 - BLACK)



3rd Row MPV Mat
(Part # 03008 - BLACK)

Weather Fortress™ for the 1st row driver and passenger:



Weather Fortress™ mats in a 2012 Nissan Armada



Weather Fortress™ mats in a 2012 Nissan Armada

5TH Avenue™ Luxury 2nd Row MPV mat for the 2nd row:

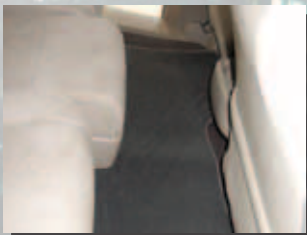

5TH Avenue™ 2nd Row MPV in a 2012 Honda Odyssey



5TH Avenue™ 2nd Row MPV in a 2012 GMC Conversion Van



5TH Avenue™ 2nd Row MPV in a 2011 Ford F-150 Extended Cab

5TH Avenue™ Luxury 3rd Row MPV mat for the 3rd row:



5TH Avenue™ 3rd Row MPV in a 2012 Honda Odyssey



5TH Avenue™ 3rd Row MPV in a 2012 GMC Conversion Van

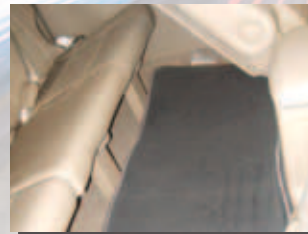

5TH Avenue™ 3rd Row MPV in a 2012 Nissan Armada



PACIFIC COAST HIGHWAY™ UNIVERSAL LUXURY CAR MATS

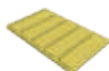

Premium long-wearing nylon heel pad



Waterproof rubber non-skid backing



UV and stain resistant



Exclusive OE style woven edge



GREY
5 PIECE SET
PART # 61507



TAN/BEIGE
5 PIECE SET
PART # 61509



BLACK
5 PIECE SET
PART # 61508

- 5 Piece carpet set
- Full 18oz. needle punch pile
- Quality non-skid waterproof backing
- Superior woven edging
- Only 'value' priced floor mats with luxury features and appearance!

Superior Quality Universal Mat Set

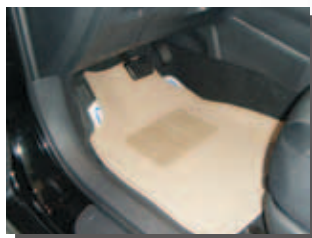

Posh Pile® Pacific Coast Highway™ mats in a 2012 Toyota Matrix



Posh Pile® Pacific Coast Highway™ mats in a 2012 Chevrolet Traverse

Pacific Coast Highway™ Gallery



Pacific Coast Highway™ in a 2012 Chrysler 200

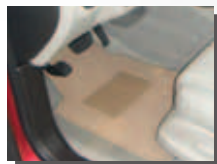

Pacific Coast Highway™ in a 2012 GMC Denali

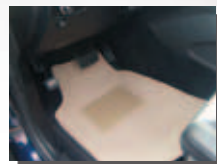

Pacific Coast Highway™ in a 2012 Jeep Grand Cherokee



Pacific Coast Highway™ in a 2012 KIA Forte



Pacific Coast Highway™ in a 2012 Nissan Juke

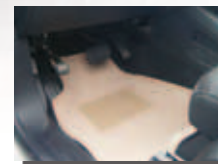

Pacific Coast Highway™ in a 2012 Dodge Journey

“LOVE THEM”
Posh Pile® US Customer

OUR LUXURY MAT!



STAY TUNED™ HIGH PERFORMANCE CAR MATS



Innovative weight saving hook anti-drift backing



Super sound deadening design



Unique tufted premium posh carpet pile

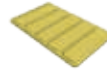

Premium long-wearing nylon heel pad



Exclusive woven edge



BLACK
5 PIECE SET
PART # 71508



TAN/BEIGE
5 PIECE SET
PART # 71509

- World's first high performance floor mats
- 60% lighter than OE replacement mats
- Unique hook 'anti-drift' backing
- Significant noise dampening quality
- Highest quality tufted posh pile
- Unique sculpted design
- 5 piece carpet mat set
- Exclusive edge and nylon woven heel pad
- High performance meets luxury!



Innovative Hook and Loop backing

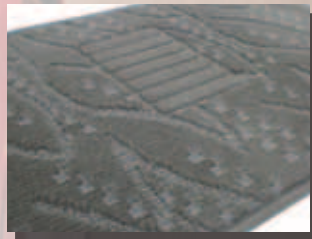

Unique tufted pile

Stay Tuned™ Gallery



Stay Tuned™ in a 2012 Chevrolet Camaro SS



Stay Tuned™ in a 2012 Lexus IS250



Stay Tuned™ in a 2012 Dodge Challenger R/T



Stay Tuned™ in a 2012 Chevrolet Sonic

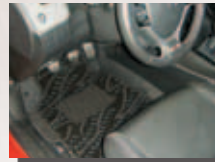

Stay Tuned™ in a 2012 Honda Civic Si



Stay Tuned™ in a 2012 Honda CRZ Hybrid

OUR PERFORMANCE MAT!



WWW.POSHPILE.COM

WEATHER FORTRESS™ SYNTHETIC RUBBER MATS

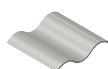

Synthetic rubber for long life



Trimable for a custom fit



Protects from sun, rain, sand, snow



Anti-skid spike prevent mat slipping

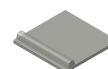

Raised lip keeps spills & liquids off your carpet



BLACK
4 PIECE SET
PART # 070478



TAN/BEIGE
4 PIECE SET
PART # 070479



GREY
4 PIECE SET
PART # 070477

- Fits 99% of vehicles on the road today
- Trimmable 17 different places
- Made of durable, high-quality synthetic rubber
- Equipped with rubber spiked backing to prevent mats from sliding
- Resistant to water, mud, chemicals, and harmful UV light
- Can be used as a 'top mat' to protect your carpet mats
- 3 colors to match today's interiors

Also available in:



2 Piece Set - Rear
TAN/BEIGE - Part # 070279



Long Rear Mat
BLACK - Part # 070378



2 Piece Set - Front
BLACK - Part # 070178

Weather Fortress™ Gallery



Weather Fortress™
in a 2012 Audi R8



Weather
Fortress™ in a
2012 Lamborghini
Gallardo



Weather Fortress™
in a 2012 GMC
Sierra

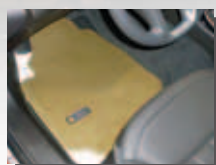

Weather Fortress™
in a 2012 Buick
Regal



Weather Fortress™
in a 2012 Hyundai
Equus



Weather Fortress™
in a 2012
Mercedes-Benz
SLS AMG

"GREAT MATS!! THANKS!"
Posh Pile® US Customer

OUR RAIN MAT!



WWW.POSHPILE.COM

WEATHER FORTRESS™ PREMIUM SYNTHETIC RUBBER MATS

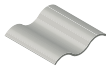

Synthetic rubber for long life



Trimmable for a custom fit



Protects from sun, rain, sand, snow



Anti-skid spike prevent mat slipping

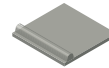

Raised lip keeps spills & liquids off your carpet



TAN/BEIGE
2 PIECE SET
PART # 080179



BLACK
2 PIECE SET
PART # 080178



GREY
2 PIECE SET
PART # 080177

- Heavy synthetic rubber for long life
- Trimmable for a custom fit
- Protection from sun, rain, sand, snow
- Large anti-skid spikes prevent mat slipping
- Higher raised lip keeps spills and liquids off your carpet
- Ideal for cold climates & heavy duty use

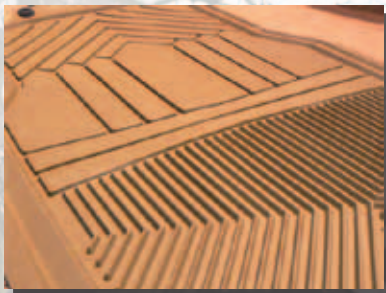

Heavy duty long wearing synthetic rubber!



Weather Fortress™ Premium 4 Piece Set
PART # 080478

Weather Fortress™ Premium Gallery



Weather Fortress™ Premium in a 2008 Chevrolet Corvette

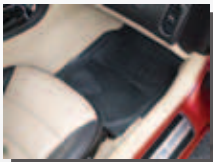

Weather Fortress™ Premium in a 2005 Chrysler Pacifica

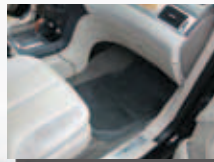

Weather Fortress™ Premium in a 2005 Jeep Wrangler



"LOVE THE MATS!!! THANKS! A+++++!"
Posh Pile® US Customer

OUR ALL WEATHER MAT!



WEATHER FORTRESS™ TRUNK/BOOT MAT

- Made of the highest quality synthetic rubber
- Tough, heavy duty abrasion resistant design
- Resistant to high and low temperatures
- Unique 'Diamond Plate' design stops your cargo from sliding
- Trimmable to fit hundreds of cars, SUV's, and MPV's



Weather Fortress™ Trunk/Boot Mat in a 2011 Subaru WRX
BLACK (PART # 090678)

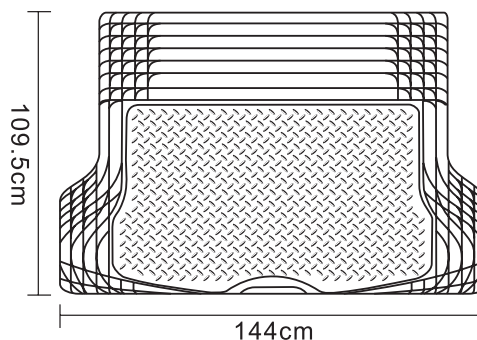

Universal Fit
144cm x 109.5cm / 56.69" x 43.11"

Weather Fortress™ Trunk/Boot Mat Gallery

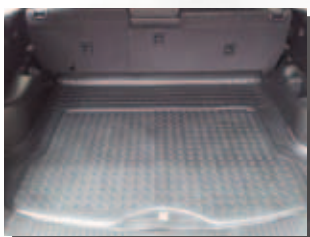

Weather Fortress™ Trunk/Boot mat in a 2012 KIA Sorrento



Weather Fortress™ Trunk/Boot mat in a 1996 BMW 5-Series



Weather Fortress™ Trunk/Boot mat in a 2011 Chrysler Pacifica

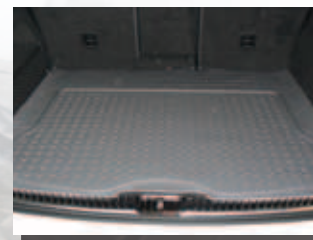

Weather Fortress™ Trunk/Boot mat in a 2011 Porsche Cayenne

OUR TRUNK MAT!



MAKE	TYPE	YEAR FROM	YEAR TO	5TH AVENUE	STAY TUNED	PACIFIC COAST HIGHWAY	DIRECT FIT MAT	WEATHER FORTRESS	WEATHER FORTRESS PREMIUM	WEATHER FORTRESS TRUNK/BOOT MAT
ACURA										
Integra	2DR	2002	2006	8150	7150	6150	NA	Fit	Fit	9067
MDX	CRX	2007	2011	8150	7150	6150	NA	Fit	Fit	9067
RDX	CRX	2007	2011	8150	7150	6150	NA	Fit	Fit	9067
TL	4DR	2009	2012	8150	7150	6150	NA	Fit	Fit	9067
TSX	4DR	2009	2011	8150	7150	6150	NA	Fit	Fit	9067
ZDX	5DR	2010	2011	8150	7150	6150	NA	Fit	Fit	9067
AUDI										
A4	4DR	1997	2012	8150	7150	6150	NA	Fit	Fit	9067
A4 Avant	WAGON	2009	2012	8150	7150	6150	NA	Fit	Fit	9067
A5	2DR	2007	2011	8150	7150	6150	NA	Fit	Fit	9067
A6	4DR	2005	2012	8150	7150	6150	NA	Fit	Fit	9067
A6 Avant	WAGON	2004	2012	8150	7150	6150	NA	Fit	Fit	9067
A7	2DR	2012	2012	8150	7150	6150	NA	Fit	Fit	9067
A8	4DR	2003	2009	8150	7150	6150	NA	Fit	Fit	9067
Q5	CRX	2009	2011	8150	7150	6150	NA	Fit	Fit	9067
Q7	CRX	2006	2011	8150	7150	6150	NA	Fit	Fit	9067
R8	2DR	2007	2012	NA	NA	NA	NA	Fit	NA	NA
S4	4DR	2009	2011	8150	7150	6150	NA	Fit	Fit	9067
S5	2DR	2007	2011	8150	7150	6150	NA	Fit	Fit	9067
TT	2DR	1999	2012	NA	NA	NA	NA	Fit	NA	NA
BMW										
128i	2DR	2008	2012	NA	NA	NA	NA	Fit	NA	9067
3-Series/M3	4DR	1998	2012	NA	NA	NA	NA	Fit	NA	9067
5-Series/M5	4DR	2004	2009	NA	NA	NA	NA	Fit	NA	9067
6-Series/M6	2DR	2004	2012	NA	NA	NA	NA	Fit	NA	9067
7-Series	4DR	2002	2008	NA	NA	NA	NA	Fit	NA	9067
850	2DR	1989	1999	8150	7150	6150	NA	Fit	Fit	9067
X3	CRX	2003	2010	NA	NA	NA	NA	Fit	NA	9067
X5/X5M	CRX	2007	2011	NA	NA	NA	NA	Fit	NA	9067
Z4	2DR	2009	2012	NA	NA	NA	NA	Fit	NA	NA
BUICK										
Enclave	CRX	2008	2012	8150	7150	6150	NA	Fit	Fit	9067
Lacrosse	4DR	2010	2012	8150	7150	6150	NA	Fit	Fit	9067
LeSabre	4DR	1992	2005	8150	7150	6150	NA	Fit	Fit	9067
Lucerne	4DR	2006	2011	8150	7150	6150	NA	Fit	Fit	9067
Regal	4DR	2011	2012	8150	7150	6150	NA	Fit	Fit	9067
Verano	4DR	2012	2012	8150	7150	6150	NA	Fit	Fit	9067
CADILLAC										
CTS Coupe	2DR	2011	2012	8150	7150	6150	NA	Fit	Fit	9067
CTS Sedan	4DR	2008	2012	8150	7150	6150	NA	Fit	Fit	9067
CTS Wagon	WAGON	2009	2012	8150	7150	6150	NA	Fit	Fit	9067
DeVille	4DR	2000	2005	8150	7150	6150	NA	Fit	Fit	9067
DTS	4DR	2006	2011	8150	7150	6150	NA	Fit	Fit	9067

Color guide: add 7 for grey, 8 for black, 9 for tan. For example 8150 is 5th Avenue, 81507 is grey, 81508 is black, 81509 is tan



MAKE	TYPE	YEAR FROM	YEAR TO	5TH AVENUE	STAY TUNED	PACIFIC COAST HIGHWAY	DIRECT FIT MAT	WEATHER FORTRESS	WEATHER FORTRESS PREMIUM	WEATHER FORTRESS TRUNK/BOOT MAT
CADILLAC										
Escalade/EXT	SUV	2007	2011	8150	7150	6150	NA	Fit	Fit	9067
SLS	4DR	2005	2011	8150	7150	6150	NA	Fit	Fit	9067
SRX	CRX	2010	2012	8150	7150	6150	NA	Fit	Fit	9067
XLR	2DR	2004	2009	8150	7150	6150	NA	Fit	Fit	NA
XTS	4DR	2013	-	8150	7150	6150	NA	Fit	Fit	9067
CHEVROLET										
Blazer	SUV	1995	2005	8150	7150	6150	NA	Fit	Fit	9067
Camaro/SS	2DR	2010	2012	8150	7150	6150	NA	Fit	Fit	9067
Cobalt	4DR	2005	2010	8150	7150	6150	NA	Fit	Fit	9067
Colorado	TRUCK	2004	2012	8150	7150	6150	NA	Fit	Fit	9067
Corvette	2DR	2005	2012	8150	7150	6150	NA	Fit	Fit	9067
Cruze	4DR	2008	2012	8150	7150	6150	NA	Fit	Fit	9067
Equinox	CRX	2010	2012	8150	7150	6150	NA	Fit	Fit	9067
Impala	4DR	2006	2012	8150	7150	6150	NA	Fit	Fit	9067
Malibu	4DR	2008	2012	8150	7150	6150	NA	Fit	Fit	9067
Silverado	TRUCK	2007	2012	8150	7150	6150	NA	Fit	Fit	9067
Sonic	4DR	2012	2012	8150	7150	6150	NA	Fit	Fit	9067
Suburban	SUV	2007	2012	8150	7150	6150	NA	Fit	Fit	9067
Traverse	CRX	2008	2012	8150	7150	6150	NA	Fit	Fit	9067
Tahoe	SUV	2007	2012	8150	7150	6150	NA	Fit	Fit	9067
CHRYSLER										
200	4DR	2011	2012	8150	7150	6150	NA	Fit	Fit	9067
300	4DR	2005	2012	8150	7150	6150	NA	Fit	Fit	9067
Aspen	SUV	2007	2009	8150	7150	6150	NA	Fit	Fit	9067
Pacifica	CRX	2004	2008	8150	7150	6150	NA	Fit	Fit	9067
PT Cruiser	5DR	2000	2010	8150	7150	6150	NA	Fit	Fit	9067
DODGE										
Caliber	4DR	2007	2011	8150	7150	6150	NA	Fit	Fit	9067
Charger	4DR	2007	2012	8150	7150	6150	NA	Fit	Fit	9067
Challenger	2DR	2008	2012	8150	7150	6150	NA	Fit	Fit	9067
Dakota	TRUCK	1997	2011	8150	7150	6150	NA	Fit	Fit	9067
Durango	SUV	2004	2009	8150	7150	6150	NA	Fit	Fit	9067
Grand Caravan	MPV	1984	2012	8150	7150	6150	NA	Fit	Fit	9067
Journey	CRX	2009	2012	8150	7150	6150	NA	Fit	Fit	9067
FORD										
Crown Victoria	4DR	1983	2011	8150	7150	6150	NA	Fit	Fit	9067
Edge	CRX	2006	2012	8150	7150	6150	NA	Fit	Fit	9067
Escape	SUV	2001	2012	8150	7150	6150	NA	Fit	Fit	9067
Expedition	SUV	2007	2012	8150	7150	6150	NA	Fit	Fit	9067
Explorer	SUV	2010	2012	8150	7150	6150	NA	Fit	Fit	9067
F-150	TRUCK	2008	2012	8150	7150	6150	NA	Fit	Fit	9067
Fiesta	4DR	2008	2012	8150	7150	6150	NA	Fit	Fit	9067
Flex	MPV	2008	2012	8150	7150	6150	NA	Fit	Fit	9067



MAKE	TYPE	YEAR FROM	YEAR TO	5TH AVENUE	STAY TUNED	PACIFIC COAST HIGHWAY	DIRECT FIT MAT	WEATHER FORTRESS	WEATHER FORTRESS PREMIUM	WEATHER FORTRESS TRUNK/BOOT MAT
FORD										
Focus	4DR	2008	2012	8150	7150	6150	NA	Fit	Fit	9067
Fusion	4DR	2010	2012	8150	7150	6150	NA	Fit	Fit	9067
Mustang	2DR	2005	2012	8150	7150	6150	NA	Fit	Fit	9067
Shelby GT500	2DR	2007	2012	8150	7150	6150	NA	Fit	Fit	9067
Taurus	4DR	2010	2012	8150	7150	6150	NA	Fit	Fit	9067
GMC										
1500 Conversion Van	MPV	2003	2012	NA	NA	NA	NA	Fit	NA	9067
1500 Conversion Van 2nd Row	MPV	2003	2012	0200	NA	NA	NA	07027	NA	9067
1501 Conversion Van 3rd Row	MPV	2003	2012	0300	NA	NA	NA	NA	NA	9067
Acadia	CRX	2007	2012	8150	7150	6150	NA	Fit	Fit	9067
Canyon	TRUCK	2004	2012	8150	7150	6150	NA	Fit	Fit	9067
Jimmy	SUV	1995	2005	8150	7150	6150	NA	Fit	Fit	9067
Savana	MPV	2003	2012	8150	7150	6150	NA	Fit	Fit	9067
Sierra	TRUCK	2007	2012	8150	7150	6150	NA	Fit	Fit	9067
Terrain	CRX	2010	2012	8150	7150	6150	NA	Fit	Fit	9067
Yukon	SUV	2000	2006	8150	7150	6150	NA	Fit	Fit	9067
Yukon Denali	SUV	2007	2012	8150	7150	6150	NA	Fit	Fit	9067
HONDA										
Accord	4DR	2008	2012	8150	7150	6150	NA	Fit	Fit	9067
Civic	4DR	1996	2012	8150	7150	6150	NA	Fit	Fit	9067
Crosstour	CRX	2010	2012	8150	7150	6150	NA	Fit	Fit	9067
CR-V	SUV	2007	2011	8150	7150	6150	NA	Fit	Fit	9067
CR-Z	2DR	2010	2012	8150	7150	6150	NA	Fit	Fit	9067
Fit	4DR	2008	2012	8150	7150	6150	NA	Fit	Fit	9067
Odyssey	MPV	2003	2012	8150	7150	6150	NA	Fit	Fit	9067
Pilot	CRX	2009	2012	8150	7150	6150	NA	Fit	Fit	9067
HYUNDAI										
Azera	4DR	2005	2012	8150	7150	6150	NA	Fit	Fit	9067
Elantra	4DR	2007	2012	8150	7150	6150	NA	Fit	Fit	9067
Equus	4DR	2009	2012	8150	7150	6150	NA	Fit	Fit	9067
Genesis	4DR	2008	2012	8150	7150	6150	NA	Fit	Fit	9067
Santa Fe	CRX	2001	2012	8150	7150	6150	NA	Fit	Fit	9067
Sonata	4DR	2004	2008	8150	7150	6150	NA	Fit	Fit	9067
Tucson	CRX	2005	2012	8150	7150	6150	NA	Fit	Fit	9067
INFINITI										
G37	2DR	2008	2011	8150	7150	6150	NA	Fit	Fit	9067
M35h	4DR	2011	2012	8150	7150	6150	NA	Fit	Fit	9067
M37	4DR	2011	2012	8150	7150	6150	NA	Fit	Fit	9067
QX56	SUV	2011	2012	8150	7150	6150	NA	Fit	Fit	9067



MAKE	TYPE	YEAR FROM	YEAR TO	5TH AVENUE	STAY TUNED	PACIFIC COAST HIGHWAY	DIRECT FIT MAT	WEATHER FORTRESS	WEATHER FORTRESS PREMIUM	WEATHER FORTRESS TRUNK/BOOT MAT
ISUZU										
I-Series	TRUCK	2006	2008	8150	7150	6150	NA	Fit	Fit	9067
JAGUAR										
S-Type	4DR	1999	2008	8150	7150	6150	NA	Fit	Fit	9067
XF	4DR	2008	2012	8150	7150	6150	NA	Fit	Fit	9067
XJ	4DR	2003	2011	8150	7150	6150	NA	Fit	Fit	9067
XJL	4DR	2010	2011	8150	7150	6150	NA	Fit	Fit	9067
XK	2DR	2006	2012	8150	7150	6150	NA	Fit	Fit	9067
JEEP										
Commander	SUV	2006	2010	8150	7150	6150	NA	Fit	Fit	9067
Compass	CRX	2007	2012	8150	7150	6150	NA	Fit	Fit	9067
Grand Cherokee	SUV	2011	2012	8150	7150	6150	NA	Fit	Fit	9067
Wrangler	SUV	1997	2006	8150	7150	6150	NA	Fit	Fit	9067
KIA										
Forte	4DR	2009	2012	8150	7150	6150	NA	Fit	Fit	9067
Optima	4DR	2010	2012	8150	7150	6150	NA	Fit	Fit	9067
Rio	4DR	2005	2012	8150	7150	6150	NA	Fit	Fit	9067
Rio Hatchback	2DR	2000	2002	8150	7150	6150	NA	Fit	Fit	9067
Sorento	CRX	2009	2012	8150	7150	6150	NA	Fit	Fit	9067
Soul	4DR	2010	2012	8150	7150	6150	NA	Fit	Fit	9067
Sportage	CRX	2010	2012	8150	7150	6150	NA	Fit	Fit	9067
LAMBORGHINI										
Gallardo	2DR	2004	2012	8150	7150	6150	NA	Fit	Fit	NA
Murcielago	2DR	2002	2011	8150	7150	6150	NA	Fit	Fit	NA
LAND ROVER										
Discovery	SUV	2008	2011	8150	7150	6150	NA	Fit	Fit	9067
LR2	CRX	2006	2011	8150	7150	6150	NA	Fit	Fit	9067
LR3	SUV	2005	2009	8150	7150	6150	NA	Fit	Fit	9067
LR4	SUV	2009	2012	8150	7150	6150	NA	Fit	Fit	9067
Range Rover HSE	SUV	2002	2012	8150	7150	6150	NA	Fit	Fit	9067
LEXUS										
CT200h	5DR	2011	2012	8150	7150	6150	NA	Fit	Fit	9067
ES330/350	4DR	1996	2011	8150	7150	6150	NA	Fit	Fit	9067
IS250/IS350	4DR	2006	2012	8150	7150	6150	NA	Fit	Fit	9067
IS250C	2DR	2006	2012	8150	7150	6150	NA	Fit	Fit	9067
LS430	4DR	2001	2006	8150	7150	6150	NA	Fit	Fit	9067
LS460L	4DR	2007	2012	8150	7150	6150	NA	Fit	Fit	9067
RX350	CRX	2004	2012	8150	7150	6150	NA	Fit	Fit	9067
RX450h	CRX	2003	2012	8150	7150	6150	NA	Fit	Fit	9067
SC430	2DR	2002	2011	8150	7150	6150	NA	Fit	Fit	NA



MAKE	TYPE	YEAR FROM	YEAR TO	5TH AVENUE	STAY TUNED	PACIFIC COAST HIGHWAY	DIRECT FIT MAT	WEATHER FORTRESS	WEATHER FORTRESS PREMIUM	WEATHER FORTRESS TRUNK/BOOT MAT
LINCOLN										
MKS	4DR	2009	2012	8150	7150	6150	NA	Fit	Fit	9067
MKX	CRX	2007	2011	8150	7150	6150	NA	Fit	Fit	9067
MKZ	4DR	2006	2012	8150	7150	6150	NA	Fit	Fit	9067
Navigator	SUV	2007	2012	8150	7150	6150	NA	Fit	Fit	9067
Town Car	4DR	1998	2011	8150	7150	6150	NA	Fit	Fit	9067
MAZDA										
3	4DR	1999	2012	8150	7150	6150	NA	Fit	Fit	9067
6	4DR	2002	2012	8150	7150	6150	NA	Fit	Fit	9067
CX-7	MPV	2007	2011	8150	7150	6150	NA	Fit	Fit	9067
CX-9	CRX	2007	2011	8150	7150	6150	NA	Fit	Fit	9067
Miata/MX-5	2DR	1989	2012	8150	7150	6150	NA	Fit	Fit	NA
MERCEDES-BENZ										
C-Class	4DR	2007	2012	NA	NA	NA	NA	Fit	Fit	9067
E-Class	4DR	2010	2012	NA	NA	NA	NA	Fit	Fit	9067
E-Class Coupe	2DR	2010	2012	NA	NA	NA	NA	Fit	Fit	9067
G-Wagon	SUV	1990	2012	NA	NA	NA	NA	Fit	Fit	9067
GL-Class	CRX	2007	2012	NA	NA	NA	NA	Fit	Fit	9067
GLK-Class	CRX	2009	2012	NA	NA	NA	NA	Fit	Fit	9067
M-Class	SUV	2006	2012	8150	7150	6150	NA	Fit	Fit	9067
R-Class	CRX	2006	2012	8150	7150	6150	NA	Fit	Fit	9067
S-Class	4DR	2006	2012	NA	NA	NA	NA	Fit	NA	9067
SL-Class	2DR	2008	2011	NA	NA	NA	NA	Fit	Fit	NA
SLK-Class	2DR	2004	2012	NA	NA	NA	NA	Fit	NA	NA
SLS AMG	2DR	2011	2012	NA	NA	NA	NA	Fit	Fit	NA
MERCURY										
Grand Marquis	4DR	1983	2011	8150	7150	6150	NA	Fit	Fit	9067
Milan	4DR	2006	2011	8150	7150	6150	NA	Fit	Fit	9067
MINI										
Cooper (R56)	2DR	2007	2012	NA	NA	NA	2156	Fit	NA	NA
MITSUBISHI										
Endeavor	CRX	2004	2011	8150	7150	6150	NA	Fit	Fit	9067
Galant	4DR	1996	2012	8150	7150	6150	NA	Fit	Fit	9067
Lancer/Evolution	4DR	1998	2011	8150	7150	6150	NA	Fit	Fit	9067
Outlander	CRX	2005	2011	8150	7150	6150	NA	Fit	Fit	9067
NISSAN										
350Z/370Z	2DR	2003	2011	8150	7150	6150	NA	Fit	Fit	NA
Altima	4DR	2002	2012	8150	7150	6150	NA	Fit	Fit	9067
Armada	SUV	2004	2012	8150	7150	6150	NA	Fit	Fit	9067
Cube	4DR	2009	2012	8150	7150	6150	NA	Fit	Fit	9067
Juke	CRX	2010	2012	8150	7150	6150	NA	Fit	Fit	9067
Leaf	5DR	2010	2012	8150	7150	6150	NA	Fit	Fit	9067



MAKE	TYPE	YEAR FROM	YEAR TO	5TH AVENUE	STAY TUNED	PACIFIC COAST HIGHWAY	DIRECT FIT MAT	WEATHER FORTRESS	WEATHER FORTRESS PREMIUM	WEATHER FORTRESS TRUNK/BOOT MAT
NISSAN										
Maxima/S	4DR	2003	2012	8150	7150	6150	NA	Fit	Fit	9067
Murano	CRX	2008	2012	8150	7150	6150	NA	Fit	Fit	9067
Quest	MPV	2011	2011	8150	7150	6150	NA	Fit	Fit	9067
Rogue	CRX	2008	2011	8150	7150	6150	NA	Fit	Fit	9067
Sentra	4DR	2007	2012	8150	7150	6150	NA	Fit	Fit	9067
Versa	4DR	2007	2012	8150	7150	6150	NA	Fit	Fit	9067
OLDSMOBILE										
Aurora	4DR	1994	2003	8150	7150	6150	NA	Fit	Fit	9067
Cutlass Supreme	2DR	1988	1997	8150	7150	6150	NA	Fit	Fit	9067
PONTIAC										
Bonneville	4DR	2000	2005	8150	7150	6150	NA	Fit	Fit	9067
G6	4DR	2005	2010	8150	7150	6150	NA	Fit	Fit	9067
G8	4DR	2009	2009	8150	7150	6150	NA	Fit	Fit	9067
Vibe	5DR	2009	2010	8150	7150	6150	NA	Fit	Fit	9067
PORSCHE										
Boxster	2DR	2005	2012	NA	NA	NA	NA	Fit	NA	NA
Cayenne	CRX	2003	2007	8150	7150	6150	NA	Fit	Fit	9067
Cayman	2DR	2006	2012	NA	NA	NA	NA	Fit	NA	NA
Panamera	4DR	2010	2012	8150	7150	6150	NA	Fit	Fit	9067
SAAB										
9-3	4DR	2002	2011	8150	7150	6150	NA	Fit	Fit	9067
9-3X	4DR	2010	2011	8150	7150	6150	NA	Fit	Fit	9067
SATURN										
Aura	4DR	2007	2009	8150	7150	6150	NA	Fit	Fit	9067
Outlook	CRX	2008	2010	8150	7150	6150	NA	Fit	Fit	9067
Vue	CRX	2002	2010	8150	7150	6150	NA	Fit	Fit	9067
SCION										
tC	2DR	2005	2011	8150	7150	6150	NA	Fit	Fit	9067
xB	4DR	2004	2011	8150	7150	6150	NA	Fit	Fit	9067
SUBARU										
Forester	WAGON	2008	2012	8150	7150	6150	NA	Fit	Fit	9067
Impreza	4DR	2001	2012	8150	7150	6150	NA	Fit	Fit	9067
Impreza WRX	4DR	2001	2012	8150	7150	6150	NA	Fit	Fit	9067
Legacy	4DR	2010	2012	8150	7150	6150	NA	Fit	Fit	9067
Outback	WAGON	2009	2012	8150	7150	6150	NA	Fit	Fit	9067
TOYOTA										
Avalon	4DR	2005	2012	8150	7150	6150	NA	Fit	Fit	9067
Camry	4DR	2002	2011	8150	7150	6150	NA	Fit	Fit	9067
Celica	2DR	1999	2006	8150	7150	6150	NA	Fit	Fit	9067



MAKE	TYPE	YEAR FROM	YEAR TO	5TH AVENUE	STAY TUNED	PACIFIC COAST HIGHWAY	DIRECT FIT MAT	WEATHER FORTRESS	WEATHER FORTRESS PREMIUM	WEATHER FORTRESS TRUNK/BOOT MAT
TOYOTA										
Corolla	4DR	2001	2012	8150	7150	6150	NA	Fit	Fit	9067
Highlander	CRX	2000	2009	8150	7150	6150	NA	Fit	Fit	9067
Land-Cruiser	SUV	2008	2012	8150	7150	6150	NA	Fit	Fit	9067
Matrix	4DR	2003	2007	8150	7150	6150	NA	Fit	Fit	9067
MR-2	2DR	2000	2007	8150	7150	6150	NA	Fit	Fit	NA
Prius	4DR	2004	2012	8150	7150	6150	NA	Fit	Fit	9067
Rav-4	CRX	2005	2012	8150	7150	6150	NA	Fit	Fit	9067
Sienna	MPV	2011	2012	8150	7150	6150	NA	Fit	Fit	9067
Venza	CRX	2009	2012	8150	7150	6150	NA	Fit	Fit	9067
Yaris	4DR	2007	2011	8150	7150	6150	NA	Fit	Fit	9067
VOLKSWAGEN										
Beetle	2DR	1998	2010	8150	7150	6150	NA	Fit	Fit	9067
CC	4DR	2009	2012	NA	NA	NA	NA	Fit	NA	9067
Eos	2DR	2007	2012	NA	NA	NA	NA	Fit	NA	9067
Golf/GTI	4DR	1991	2012	NA	NA	NA	NA	Fit	NA	9067
Jetta	4DR	2001	2012	NA	NA	NA	NA	Fit	NA	9067
Jetta Wagon	WAGON	2001	2012	NA	NA	NA	NA	Fit	NA	9067
Passat	4DR	2006	2011	NA	NA	NA	NA	Fit	NA	9067
Routan	MPV	2009	2011	NA	NA	NA	NA	Fit	NA	9067
Tiguan	CRX	2009	2012	NA	NA	NA	NA	Fit	NA	9067
Touareg	CRX	2002	2011	8150	7150	6150	NA	Fit	Fit	9067
VOLVO										
240	4DR	1974	1993	8150	7150	6150	NA	Fit	Fit	9067
C70	2DR	2006	2012	8150	7150	6150	NA	Fit	Fit	NA
S40	4DR	1995	2009	8150	7150	6150	NA	Fit	Fit	9067
S60	4DR	2000	2002	8150	7150	6150	NA	Fit	Fit	9067
S70	4DR	1997	2000	8150	7150	6150	NA	Fit	Fit	9067
S80	4DR	1998	2012	8150	7150	6150	NA	Fit	Fit	9067
V50	WAGON	2003	2011	8150	7150	6150	NA	Fit	Fit	9067
XC60	CRX	2008	2012	8150	7150	6150	NA	Fit	Fit	9067
XC70	WAGON	2007	2012	8150	7150	6150	NA	Fit	Fit	9067
XC90	CRX	2003	2012	8150	7150	6150	NA	Fit	Fit	9067



TRUNK ORGANIZATION

TRUNK/BOOT STORAGE BAG

- Organizes safety, car cleaning products and tools
- Hook & loop tape included to affix bag securely to trunk
- Removes from trunk and can be carried as a tool bag
- Soft pile protects contents and deadens sound
- "Smart design" fits most cars, trucks, and SUV's
- Available in black or grey to match trunk interiors



BLACK
PART # 00308



GREY
PART # 00307

Dimensions: Length x Height x Depth
20 x 9 x 6.5 inches
50.8 x 22.86 x 16.51 cm

THE PERFECT "TRUNK UPGRADE"!

INTERIOR CARE

12-VOLT CAR VACUUM

- High suction 12-volt motor
- 5 meter (Over 16 ft.) long cord - long enough to stretch from the dashboard to the trunk
- Easy to clean filter
- Adjustable nozzle that gets into small spaces
- Includes a trunk storage bag
- Removes tough dirt



12-VOLT CAR VACUUM
PART # 00100

Unlike conventional rechargeable car vacuums, the Posh Pile® 12-volt vacuum will not lose suction as you clean! Finally a powerful car vacuum!



EXTERIOR CARE

RANDOM ORBITAL POLISHER

- Advanced random orbital motion reduces swirls and paint damage
- Accepts professional 6" foam pads
- Also can be used for applying and removing wax
- 12-volt power with a 5 meter (16.4 feet) cord
- 220-volt power with a 2 meter (6.5 feet) cord
- Bonus: Includes 6" foam pad for polishing and a bonnet for waxing!
(All you need is wax & polish)
- Polish cars, boats, trucks and more!

Available in 12-volt and 220-volt versions!



220-Volt Random
Orbital Polisher
PART # 00220



12-Volt Random
Orbital Polisher
PART # 00200

Includes:



FOAM PAD



MICROFIBER
BONNET

FOAM POLISHING PAD

- Removes swirls and surface imperfections
- Professional quality
- Works with hook and loop fastening system to fit 6" backing plates
- Use with Posh Pile® orbital polishers above



FOAM POLISHING PAD
PART # 00201



EXTERIOR CARE

WASH GLOVE HANDLE

- Fits Posh Pile® 00252 Microfiber Wash Glove to create a wash mop
- Lightweight, soft grip design
- Handle extends from 29" to 49"

Combined with our Microfiber Wash Glove, it's easy to reach any part of your vehicle.



WASH GLOVE HANDLE
PART # 00253

MICROFIBER CAR DUSTER

- Advanced twisted long strand micro fiber technology that safely lifts dust
- 12" lightweight non-breakable composite handle
- Handy storage bag keeps your duster clean
- Will not scratch paint
- For interior and exterior use
- 13" washable microfiber head
- Great for waterless cleaning



MICROFIBER CAR DUSTER
PART # 00250

CAR SHAMPOO SPONGE

- Easy to grip
- Holds more soap and water
- Economical/durable
- Porous to lift grime and dirt away from your paint
- The perfect car wash partner!



CAR SHAMPOO SPONGE
PART # 00251

WHEEL SPOKE BRUSH

- Strong and flexible for cleaning hard to reach areas
- Long bristles loosen and remove brake dust, dirt, and grime
- Lightweight with a soft grip handle for ultimate control
- Exclusive lug brush
- Hangable



WHEEL SPOKE BRUSH
PART # 00254

ADVANCED WHEEL FACE BRUSH

- Ergonomic soft rubber grip
- Soft bristles protect the finest wheels/rims
- Bristles designed to stand up to harsh wheel cleaners
- Hangable



WHEEL FACE BRUSH
PART # 00255



RETAIL CENTER

PP-2 RACK

- Welded steel design collapses for easy shipping in one box
- Black powder coating
- Smooth moving wheels
- Double sided Posh Pile® logo header
- Comes with necessary tools & fasteners for installation

Dimensions with Header Card:

Length x Width x Height
 41.5 x 19.75 x 68.75 inches
 105.4 x 50.17 x 174.63 cm

Dimensions without Header Card:

Length x Width x Height
 41.5 x 19.75 x 58.25 inches
 105.4 x 50.17 x 147.96 cm



PP-2 RACK FEATURING POSH PILE® CARPET MATS

PP-2 RACK FEATURING POSH PILE® RUBBER MATS

THE PERFECT RETAIL SHOWCASE!



Ultimate  Luxury



Posh Pile®
Check out our newest products,
get the latest news, buy
Posh Pile® online.



Facebook
"Like" our page, view our photo
albums, communicate with other
Posh Pile® owners, and tell us what
you think.



Youtube
Watch more than 70 videos and see
Posh Pile® products in over 300
vehicles!



Twitter
Get the updates, be the first to
hear about new products, and learn
what's going on at Posh Pile®.



All About Car Mats blog
www.allaboutcarmats.com
Find the best information about
car mats and truthful educational
information.



All About Car Detailing blog
www.detail-my-car.com
Learn how to detail your car the
professional, and easy, way



www.poshpile.com



www.facebook.com/PoshPile



www.youtube.com/luxuryposhpile



www.twitter.com/poshpile

Find Posh Pile® in: the
U.S.A., Canada, Hong
Kong, Dubai, Saudi
Arabia, Columbia, China,
Oman, Malaysia, New
Zealand, Singapore, and
Thailand

Authorized Distribution Partner:



Unit G, 11/F, Sunview Building, No.3 On Yip Street,
Chai Wan, Hong Kong Phone: (852) 2967 - 0202

Posh Pile is a registered trademark and 5TH Avenue, Stay Tuned, Pacific
Coast Highway, and Weather Fortress are trademarks of International
Market Access Ltd.
© 2012 Posh Pile®